

# Wellness and Swimming Pools



**RAK**  
CERAMICS

**RAK**  
CERAMICS



Floor: Swimming Pool Light Blue, Lava Concrete Light Grey, Lava Concrete Light Grey Step and Riser

## Wellness And Swimming Pools

Swimming pool and Spa surfaces requires careful attention in terms of application and design selection.

RAK Ceramics innovative solutions for Swimming pool and Wellness are up to date with the latest trends in tile design as well as in technical excellence and quality standards. Outdoor or indoor projects, we have the products and expertise to provide the perfect solution in terms of comfort and safety, leaving to the architects and interior designers the limitless possibility to express their imagination. RAK Ceramics' tiles are designed to ensure perfect integration of your pool projects to its surrounding landscape and interior design style, eliminating aesthetic boundaries. The comprehensive product range comes in various sizes, materials, designs, accessories and even steps and edges making it a complete pool solution.

Enjoy your leisure time in a stylish environment that fully reflects your personality.



Floor : Swimming Pool Light Blue and Dark Blue,  
Creative Concrete P Grey and creative concrete p special piece



Floor : Swimming Pool Light Blue, French Vanilla Grey and French Vanilla Grey Special Piece

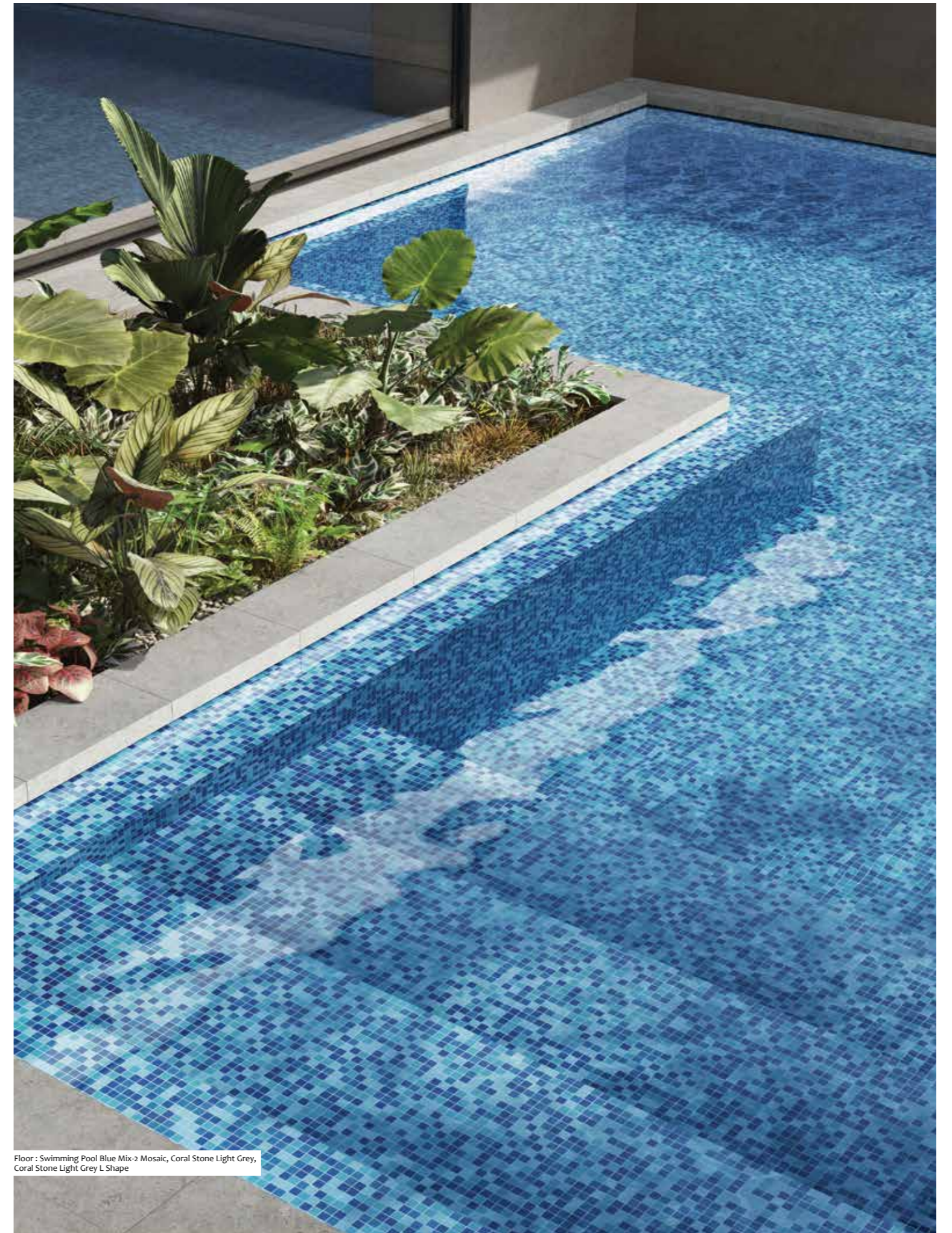

Floor : Swimming Pool Blue Mix-2 Mosaic, Coral Stone Light Grey, Coral Stone Light Grey L Shape



Floor : Swimming Pool Light Blue, Swimming Pool Beige Channel Hole and Siena Stone Deep Sand



Floor: Swimming Pool Light Blue C, Swimming Pool Light Blue Step, Swimming Pool Light Blue, Swimming Pool Dark Blue, Fashion Stone Grey, Fashion Stone Grey Special Pieces



Floor: Swimming Pool Light Blue, Lava Concrete beige





Floor: Swimming Pool Light Blue, Coral Stone Ivory

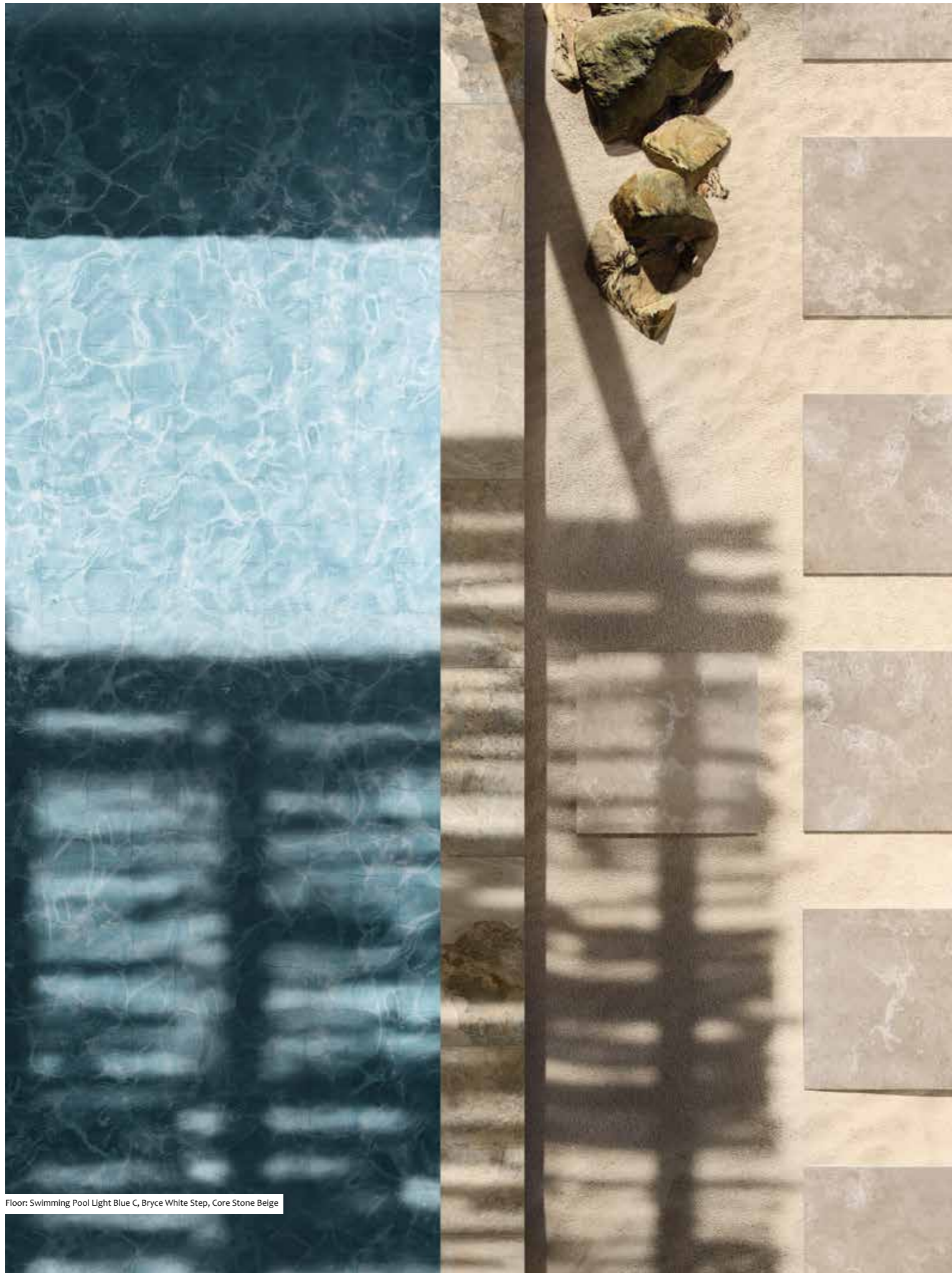

Floor: Swimming Pool Light Blue C, Bryce White Step, Core Stone Beige



Floor: Swimming Pool Light Blue C, Bryce White Step, Core Stone Beige



Wall: Design Concrete Grey  
Floor: Design Concrete Grey, Design Concrete Grey Mosaic

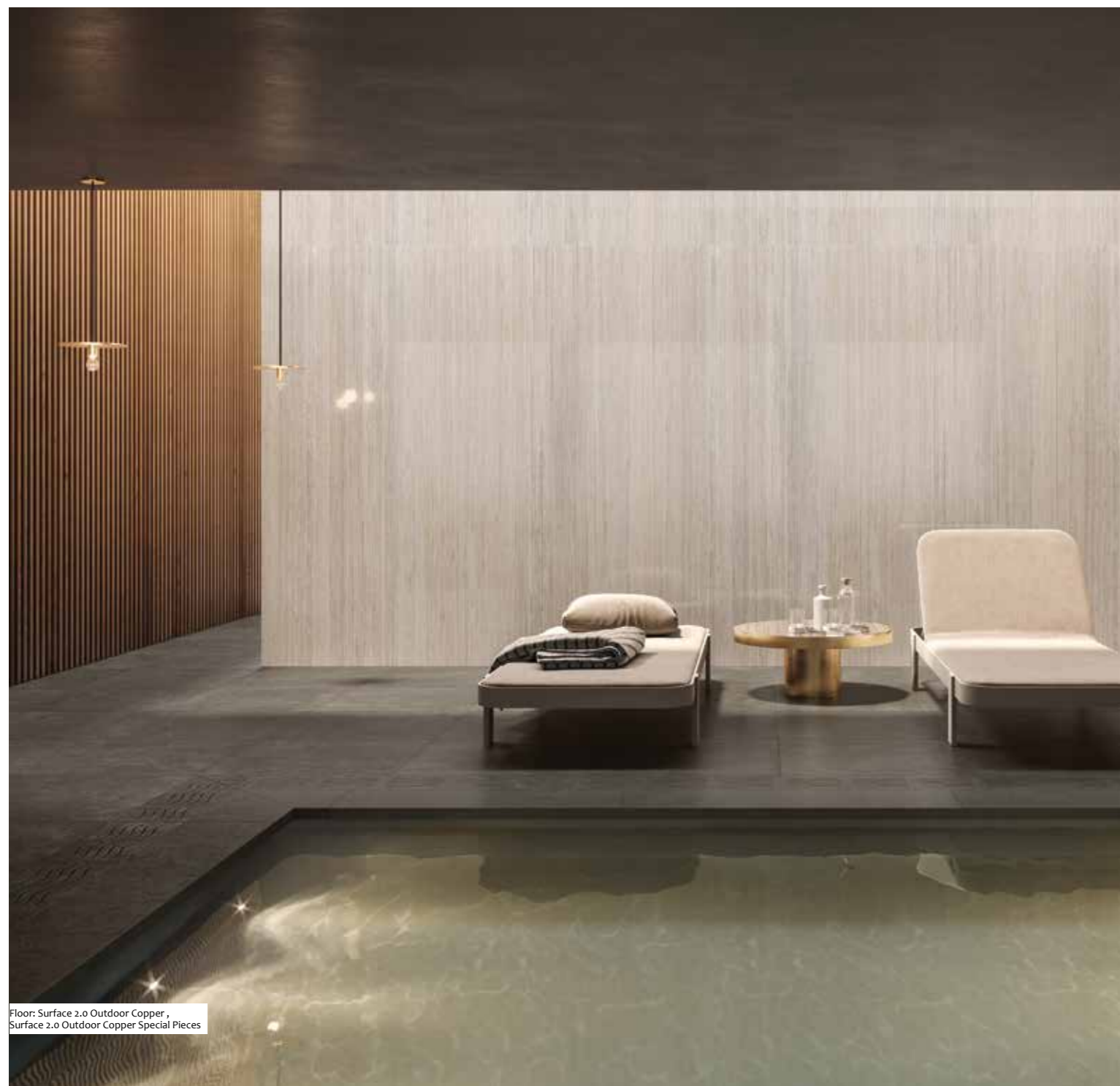

Floor: Surface 2.0 Outdoor Copper ,  
Surface 2.0 Outdoor Copper Special Pieces



Floor: Revive Concrete Graphite Grey



Floor: Coral Stone Beige, Coral Stone Beige Special Pieces, Swimming Pool Beige Mosaic



Floor: Surface 2.0 Outdoor Copper,  
Surface 2.0 Outdoor Copper Special Pieces

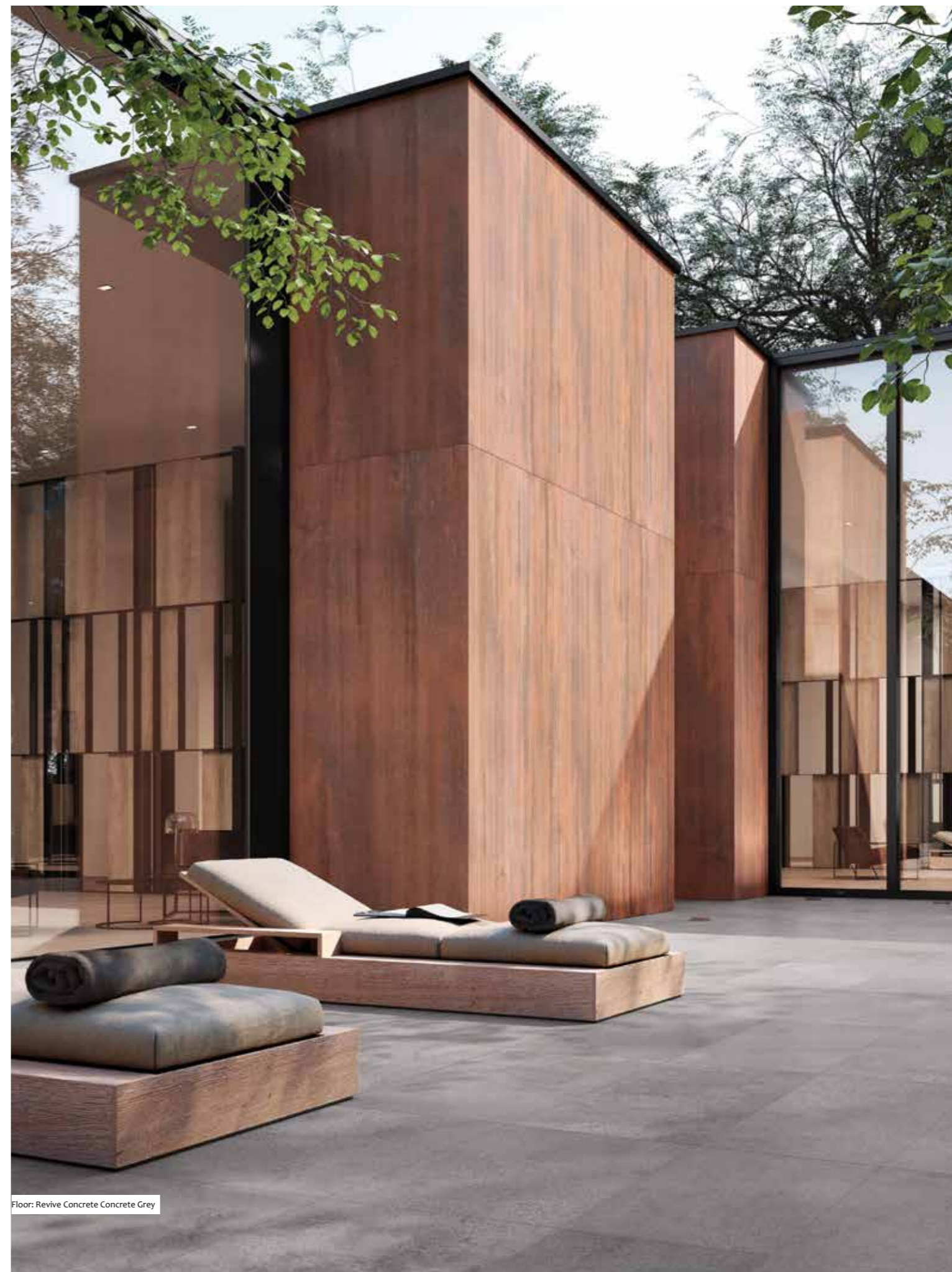

Floor: Revive Concrete Concrete Grey



Floor: Shine Stone Beige



Floor: Swimming Pool Light Blue Mosaic, Revive Concrete Graphite Grey, Revive Concrete Grey Special Pieces





Wall: Swimming Pool Beige, White and Dark Blue  
Floor: Swimming Pool Light Blue and Dark

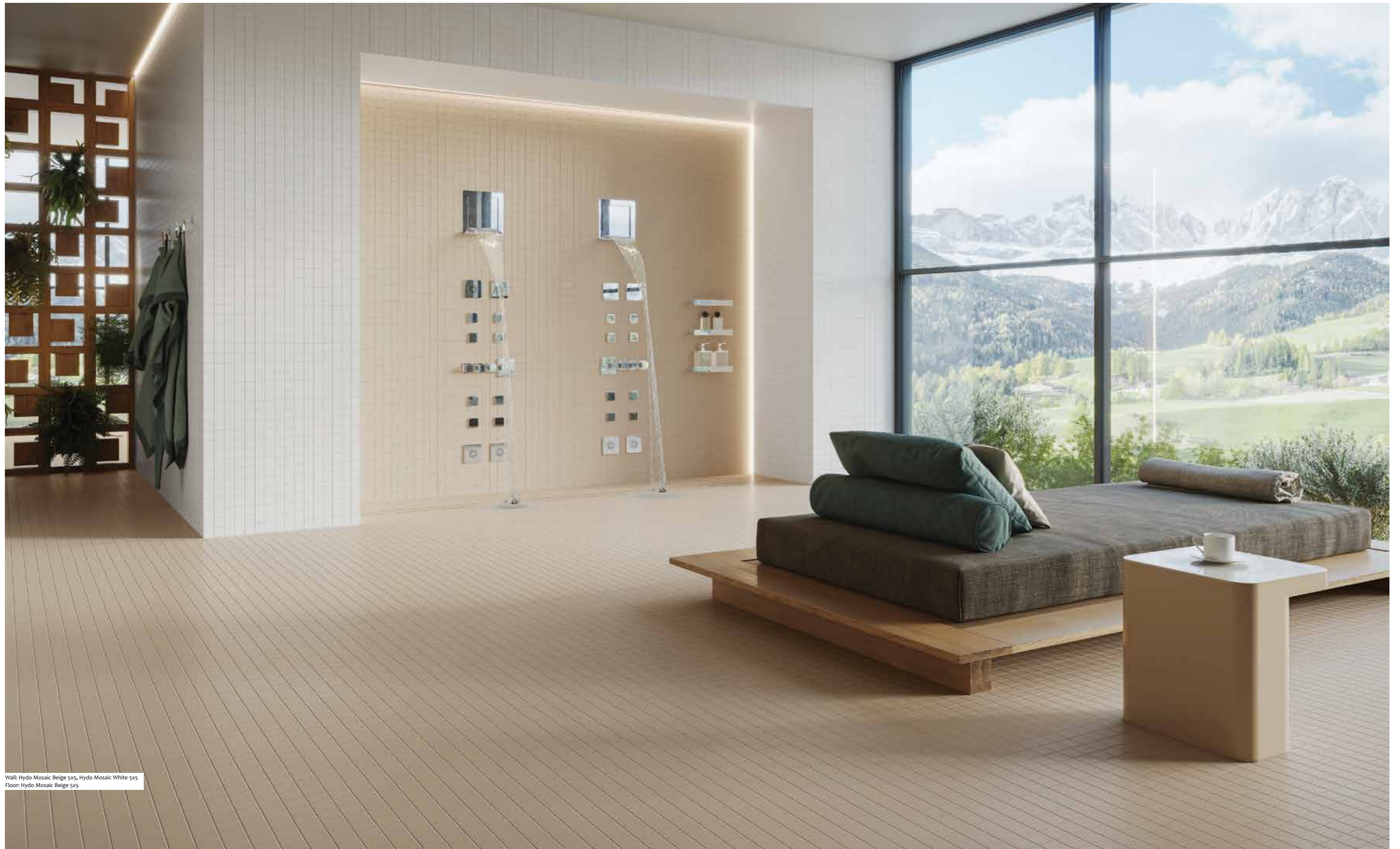

Wall: Hydo Mosaic Beige 5x5, Hydo Mosaic White 5x5  
Floor: Hydo Mosaic Beige 5x5



Wall: Hydo Mosaic White 5x5  
Floor: Hydo Mosaic White 5x5

# Swimming pool

GRESS WHITE BODY TILES

Matt / Glossy • Straight • Smooth / Light Structure







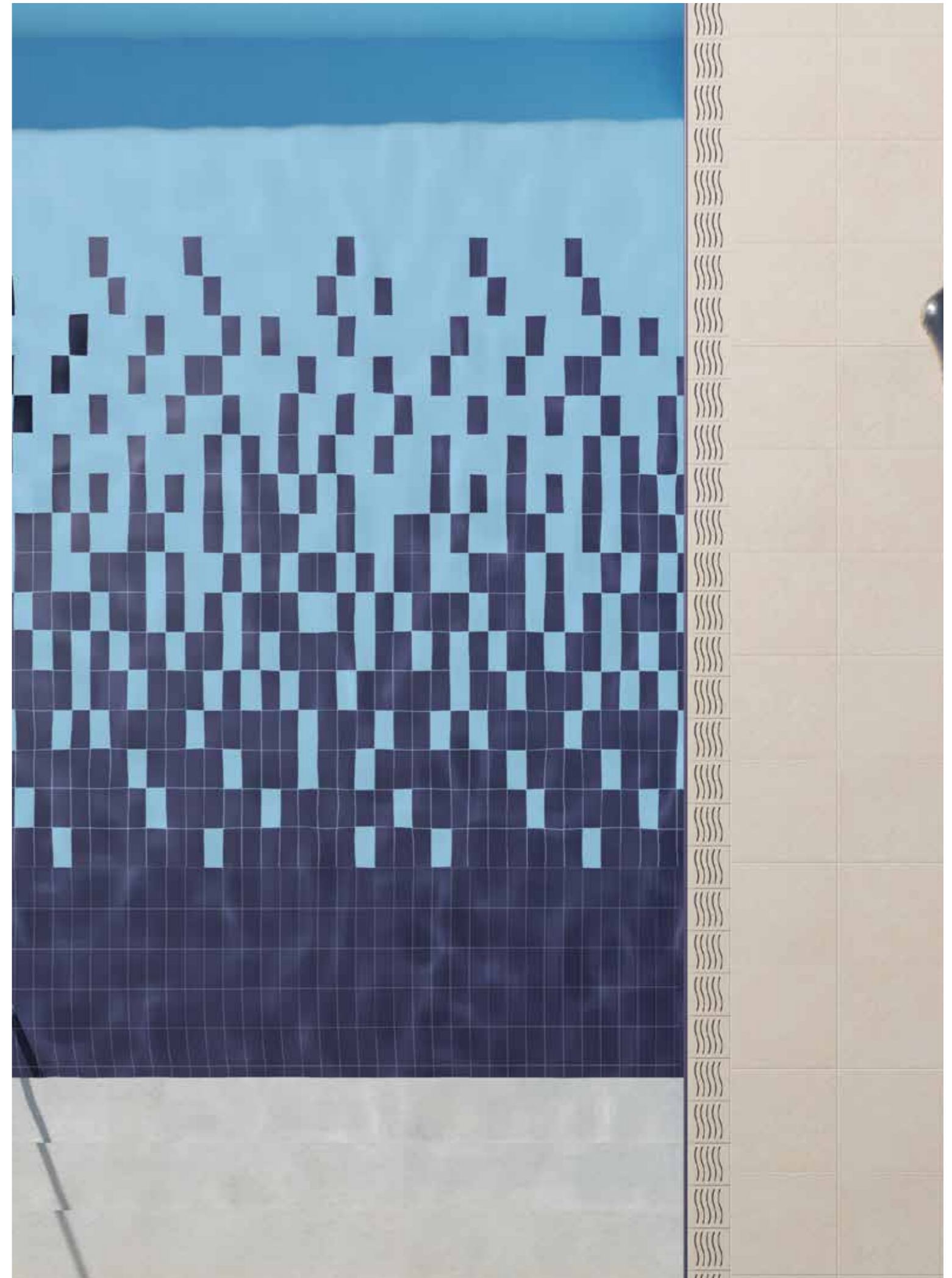
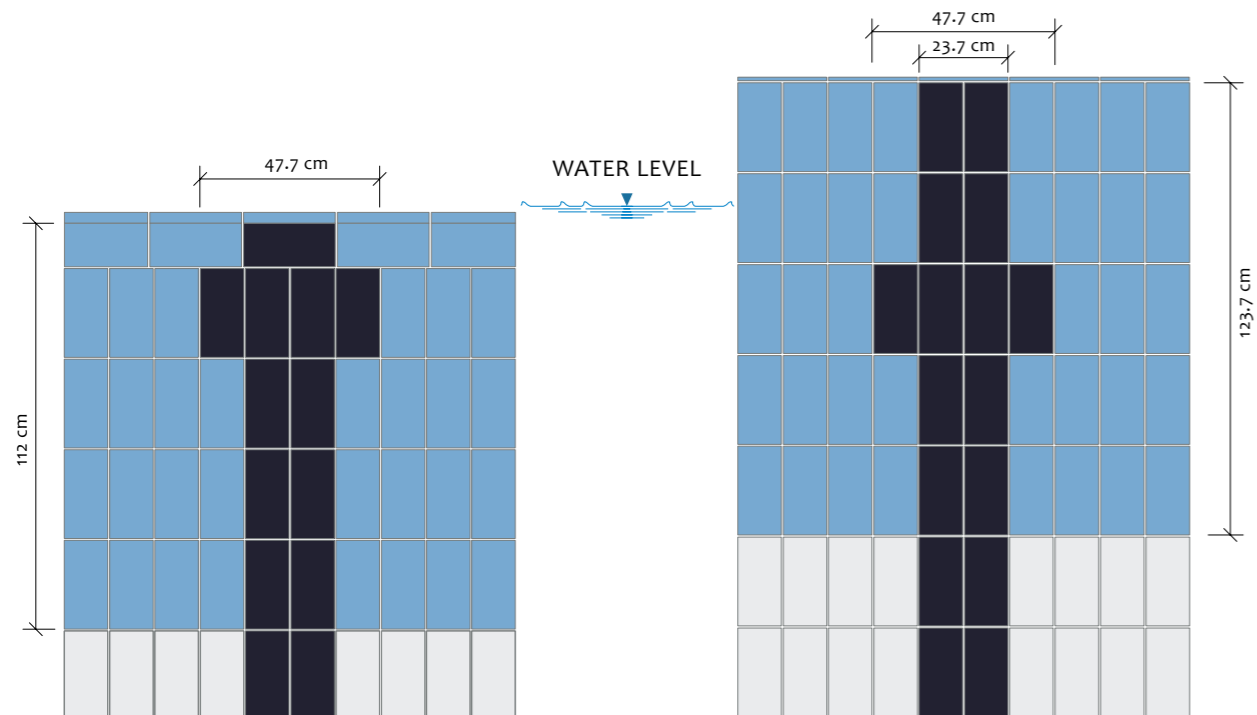
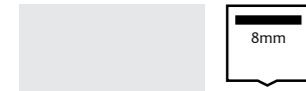





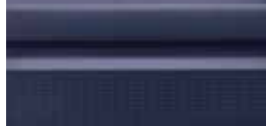

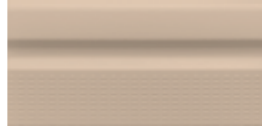
## SIZES

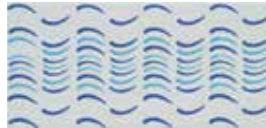
11.7x24.5 cm  
4.60"x9.64"









# Swimming pool

## Decor

|  |   |   |  |   |   |
|--|---|---|--|---|---|
|  |  |  |  |  |   |
| sky blue step  | navy blue step  | white step  | grey step  | beige step  |   |
|  |  |  |  |  |   |
| navy blue / sky blue step  | sp-sky a<br>11.7x24.5 cm /<br>4.60"x9.64"   | sp-sky b<br>11.7x24.5 cm /<br>4.60"x9.64"   | sp-wave<br>11.7x24.5 cm /<br>4.60"x9.64"   | chequered cut sky blue*<br>11.7x11.7 cm /<br>4.60"x4.60"                            |   |
|  |  |  |   |   |  |
| angle bead external*<br>2.7x24.5 cm /<br>1.06"x9.64"                             | angle bead internal*<br>2.7x24.5 cm /<br>1.06"x9.64"                              | corner external*<br>2.7x2.7 cm /<br>1.06" x1.06"                                  | corner internal*<br>2.7x2.7 cm /<br>1.06" x1.06"                                   | Elephant Foot external*<br>2.7x2.7 cm /<br>1.06" x1.06"                             | Elephant Foot internal*<br>2.7x2.7 cm /<br>1.06" x1.06"                             |

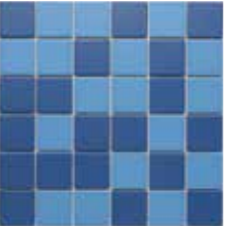
 \*Available colours matt

## Mosaic

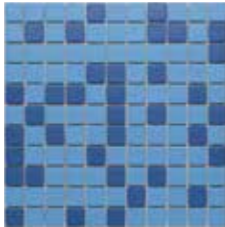
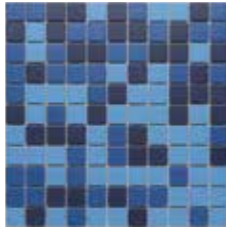
|  |   |   |   |   |
|--|---|---|---|---|
|  |  |  |  | mosaic 5x5<br>31x31 cm<br>12.2"x12.2"           |
| beige mix-2 mosaic 5x5   | beige mix-3 mosaic 5x5  | blue mix-2 mosaic 5x5   | blue mix-3 mosaic 5x5   |   |
|  |  |  |  | mosaic 2.5x2.5<br>29.7x29.7 cm<br>11.69"x11.69" |
| beige mix-2 mosaic 2.5x2.5   | beige mix-3 mosaic 2.5x2.5  | blue mix-2 mosaic 2.5x2.5   | blue mix-3 mosaic 2.5x2.5   |   |

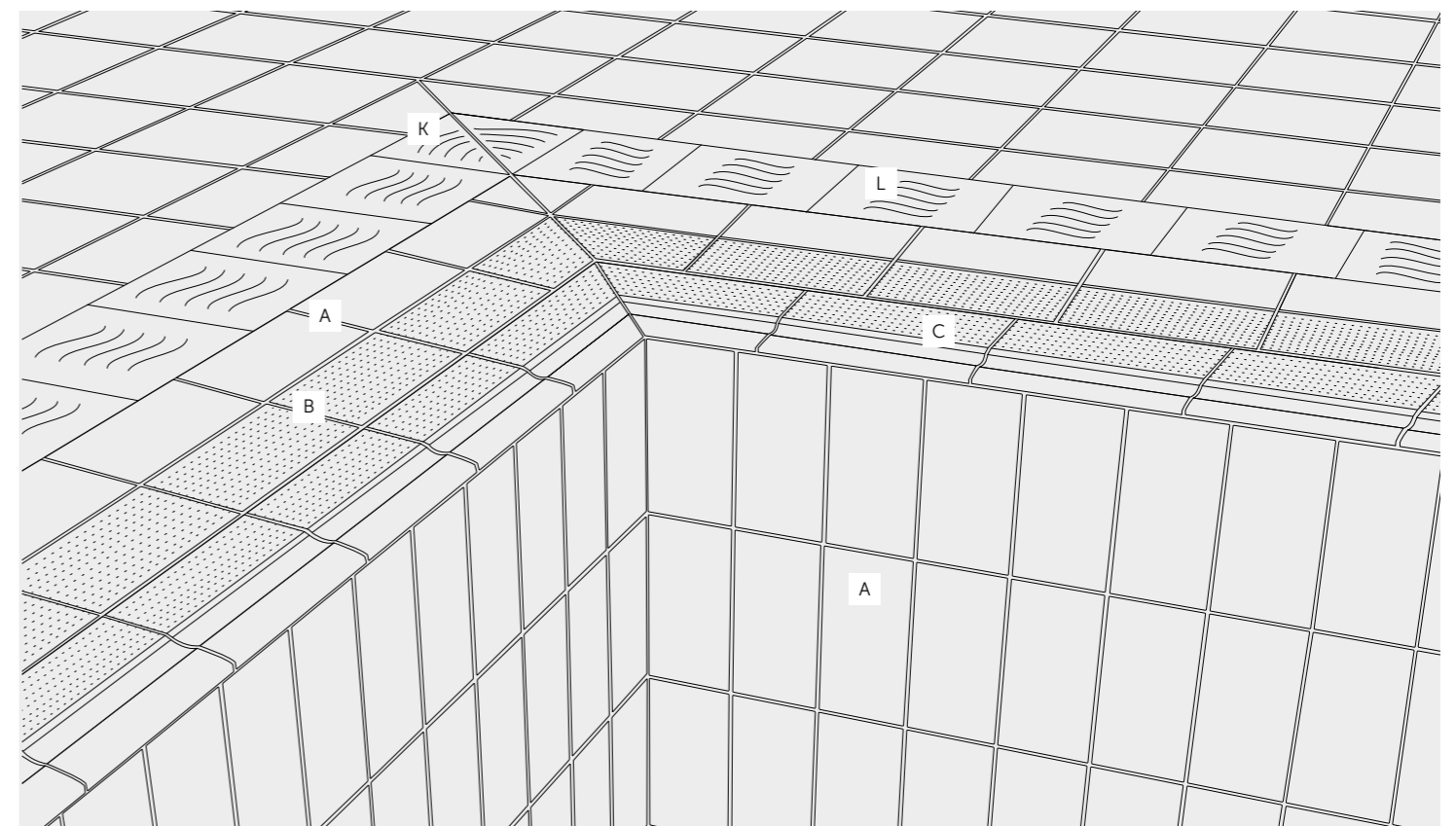
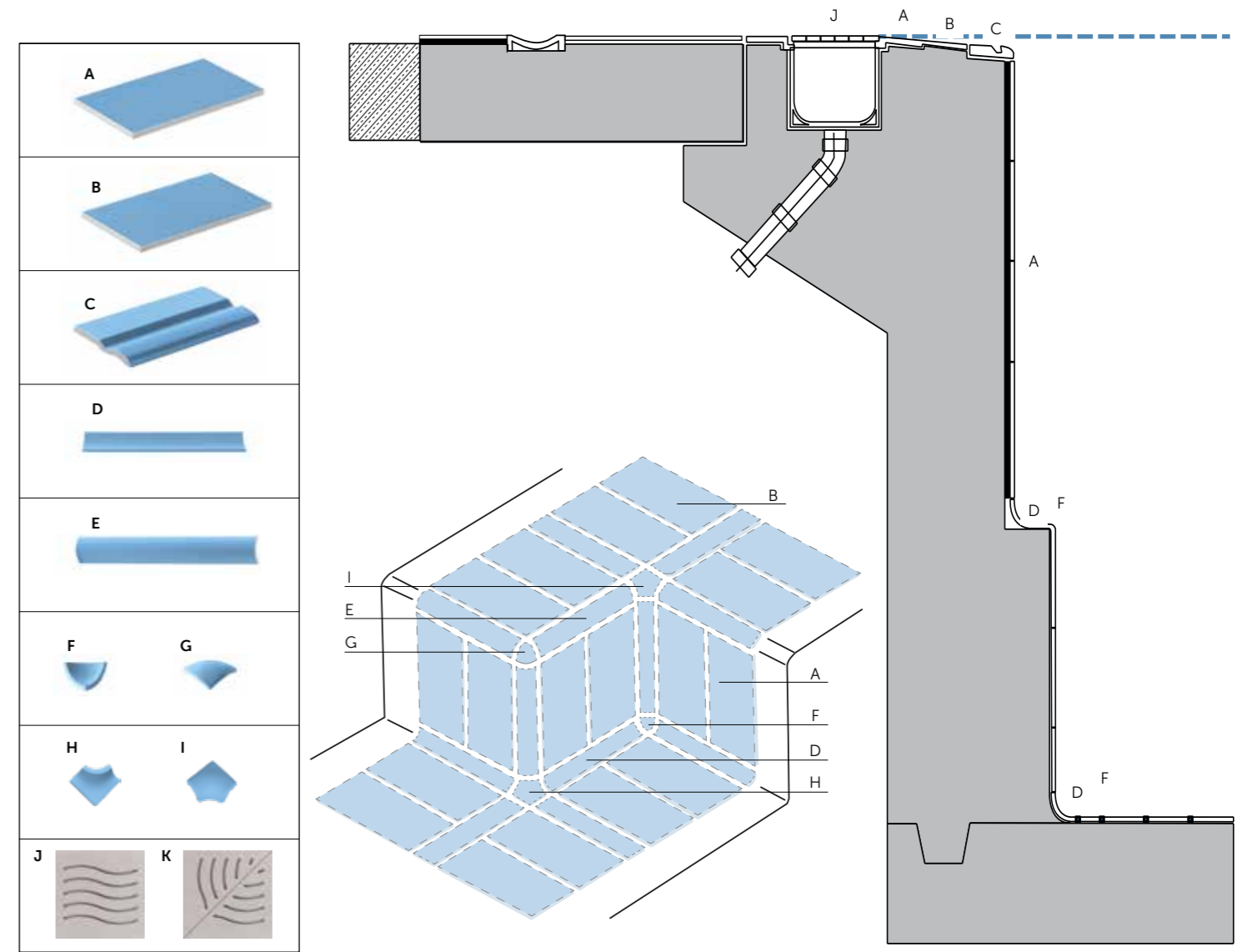

# Swimming pool

Channel Plain

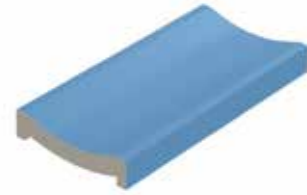

11.7X24.5 cm  
4.60"x9.64"



Available colours  
matt

Channel Hole

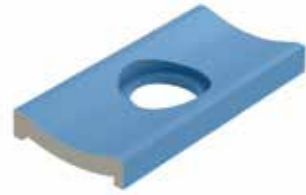

11.7X24.5 cm  
4.60"x9.64"



Available colours  
matt

Channel Edge



11.7X24.5 cm  
4.60"x9.64"



Available colours  
matt

| Name                             | Code matt          | Size(CM)  | Name                             | Code glossy        | Size(CM)  |
|----------------------------------|--------------------|-----------|----------------------------------|--------------------|-----------|
| sky blue                         | A21SHYDO-SKB.MoXoU | 11.7x24.5 | sky blue                         | A21SHYDO-SKB.GoXoU | 11.7x24.5 |
| navy blue                        | A21SHYDO-NAY.MoXoU | 11.7x24.5 | navy blue                        | A21SHYDO-NAY.GoXoU | 11.7x24.5 |
| beige                            | A21SHYDO-BEE.MoXoU | 11.7x24.5 | beige                            | A21SHYDO-BEE.GoXoU | 11.7x24.5 |
| white                            | A21SHYDO-WHE.MoXoU | 11.7x24.5 | white                            | A21SHYDO-WHE.GoXoU | 11.7x24.5 |
| grey                             | A21SHYDO-GRY.MoXoU | 11.7x24.5 | grey                             | A21SHYDO-GRY.GoXoU | 11.7x24.5 |
| sky blue step                    | AGTZZHYDOSKB063849 | 11.7x24.5 | sky blue step                    | AGTZZHYDOSKB063850 | 11.7x24.5 |
| navy blue step                   | AGTZZHYDONAY063851 | 11.7x24.5 | navy blue step                   | AGTZZHYDONAY063852 | 11.7x24.5 |
| beige step                       | AGTZZHYDOBEE063853 | 11.7x24.5 | beige step                       | AGTZZHYDOBEE063854 | 11.7x24.5 |
| white step                       | AGTZZHYDOWHE063855 | 11.7x24.5 | white step                       | AGTZZHYDOWHE063856 | 11.7x24.5 |
| grey step                        | AGTZZHYDOGRY063857 | 11.7x24.5 | grey step                        | AGTZZHYDOGRY063858 | 11.7x24.5 |
| Name matt                        | Code               | Size(CM)  | Name                             | Code               | Size(CM)  |
| sky blue dotted                  | A21SHYDO-SKB.MTXoU | 11.7x24.5 | sky blue / navy blue step        | AGTZZHYDOSKB064339 | 11.7x24.5 |
| navy blue dotted                 | A21SHYDO-NAY.MTXoU | 11.7x24.5 |                                  |                    |           |
| beige dotted                     | A21SHYDO-BEE.MTXoU | 11.7x24.5 |                                  |                    |           |
| white dotted                     | A21SHYDO-WHE.MTXoU | 11.7x24.5 |                                  |                    |           |
| grey dotted                      | A21SHYDO-GRY.MTXoU | 11.7x24.5 |                                  |                    |           |
| angle bead external sky blue     | AWNZZHYDOSKB063619 | 2.7x24.5  | angle bead internal sky blue     | AWNZZHYDOSKB063655 | 2.7x24.5  |
| angle bead external navy blue    | AWNZZHYDONAY063620 | 2.7x24.5  | angle bead internal navy blue    | AWNZZHYDONAY063652 | 2.7x24.5  |
| angle bead external beige        | AWNZZHYDOBEE063621 | 2.7x24.5  | angle bead internal beige        | AWNZZHYDOBEE063653 | 2.7x24.5  |
| angle bead external white        | AWNZZHYDOWHE063622 | 2.7x24.5  | angle bead internal white        | AWNZZHYDOWHE063654 | 2.7x24.5  |
| angle bead external grey         | AWNZZHYDOGRY063623 | 2.7x24.5  | angle bead internal grey         | AWNZZHYDOGRY063651 | 2.7x24.5  |
| conner external sky blue         | AWOZZHYDOSKB063703 | 2.7x2.7   | conner internal sky blue         | AWOZZHYDOSKB063709 | 2.7x2.7   |
| conner external navy blue        | AWOZZHYDONAY064439 | 2.7x2.7   | conner internal navy blue        | AWOZZHYDONAY063680 | 2.7x2.7   |
| conner external beige            | AWOZZHYDOBEE063705 | 2.7x2.7   | conner internal beige            | AWOZZHYDOBEE063681 | 2.7x2.7   |
| conner external white            | AWOZZHYDOWHE063706 | 2.7x2.7   | conner internal white            | AWOZZHYDOWHE063682 | 2.7x2.7   |
| conner external grey             | AWOZZHYDOGRY063707 | 2.7x2.7   | conner internal grey             | AWOZZHYDOGRY063683 | 2.7x2.7   |
| elephant foot external sky blue  | AWOZZHYDOSKB063898 | 2.7x2.7   | elephant foot internal sky blue  | AWOZZHYDOSKB063731 | 2.7x2.7   |
| elephant foot external navy blue | AWOZZHYDONAY063899 | 2.7x2.7   | elephant foot internal navy blue | AWOZZHYDONAY063732 | 2.7x2.7   |
| elephant foot external beige     | AWOZZHYDOBEE063900 | 2.7x2.7   | elephant foot internal beige     | AWOZZHYDOBEE063733 | 2.7x2.7   |
| elephant foot external white     | AWOZZHYDOWHE063901 | 2.7x2.7   | elephant foot internal white     | AWOZZHYDOWHE063734 | 2.7x2.7   |
| elephant foot external grey      | AWOZZHYDOGRY063902 | 2.7x2.7   | elephant foot internal grey      | AWOZZHYDOGRY063735 | 2.7x2.7   |
| blue mix-2 mosaic 2.5x2.5        | ASMZZHYDOMS2025466 | 29.7x29.7 | beige mix-2 mosaic 2.5x2.5       | ASMZZHYDOMS2025454 | 29.7x29.7 |
| blue mix-3 mosaic 2.5x2.5        | ASMZZHYDOMS3025467 | 29.7x29.7 | beige mix-3 mosaic 2.5x2.5       | ASMZZHYDOMS3025468 | 29.7x29.7 |
| blue mix-2 mosaic 5x5            | ASMZZHYDOMS2025456 | 31x31     | beige mix-2 mosaic 5x5           | ASMZZHYDOMS2025455 | 31x31     |
| blue mix-3 mosaic 5x5            | ASMZZHYDOMS3025469 | 31x31     | beige mix-3 mosaic 5x5           | ASMZZHYDOMS3025470 | 31x31     |



| Name                    | Code               | Size(CM)  | Name                   | Code            | Size(CM)  |
|-------------------------|--------------------|-----------|------------------------|-----------------|-----------|
| chequered cut sky blue  | AGWZZHYDOSKB064563 | 11.7X11.7 | sp-wave                | AST-21WAVE      | 11.7x24.5 |
| chequered cut navy blue | AGWZZHYDONAY064564 | 11.7X11.7 | sp-sky a               | AST-21SKY-A     | 11.7x24.5 |
| chequered cut beige     | AGWZZHYDOBEE064565 | 11.7X11.7 | sp-sky b               | AST-21SKY-B     | 11.7x24.5 |
| chequered cut white     | AGWZZHYDOWHE064566 | 11.7X11.7 |                        |                 |           |
| chequered cut grey      | AGWZZHYDOGRY064567 | 11.7X11.7 |                        |                 |           |
| channel sky blue        | SPTP2412SWPSBMA    | 11.7x24.5 | channel hole sky blue  | SPTH2512SWPSBMA | 11.7x24.5 |
| channel navy blue       | SPTP2412SWPNBMA    | 11.7x24.5 | channel hole navy blue | SPTH2512SWPNBMA | 11.7x24.5 |
| channel beige           | SPTP2412SWPBMA     | 11.7x24.5 | channel hole beige     | SPTH2512SWPBMA  | 11.7x24.5 |
| channel white           | SPTP2412SWPWMA     | 11.7x24.5 | channel hole white     | SPTH2512SWPWMA  | 11.7x24.5 |
| channel grey            | SPTP2412SWPGMA     | 11.7x24.5 | channel hole grey      | SPTH2512SWPGMA  | 11.7x24.5 |
| channel edge sky blue   | SPTPE2412SWPSBMA   | 11.7x24.5 |                        |                 |           |
| channel edge navy blue  | SPTPE2412SWPNBMA   | 11.7x24.5 |                        |                 |           |
| channel edge beige      | SPTPE2412SWPBMA    | 11.7x24.5 |                        |                 |           |
| channel edge white      | SPTPE2412SWPWMA    | 11.7x24.5 |                        |                 |           |
| channel edge grey       | SPTPE2412SWPGMA    | 11.7x24.5 |                        |                 |           |

# Hydo Mosaic

GRESS WHITE BODY TILES  
Matt / Glossy • Straight • Smooth

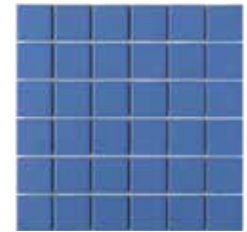

hydo mosaic blue 5x5

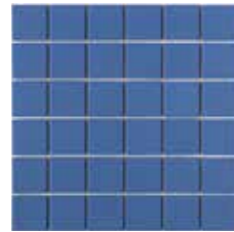

hydo mosaic dark blue 5x5

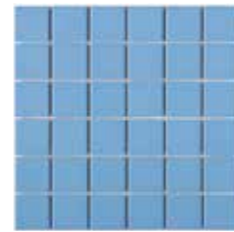

hydo mosaic sky blue 5x5

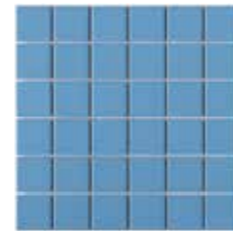

hydo mosaic medium blue 5x5



hydo mosaic navy blue 5x5



hydo mosaic black 5x5



hydo mosaic dark beige 5x5



hydo mosaic beige 5x5



hydo mosaic dark grey 5x5



hydo mosaic grey 5x5



hydo mosaic white 5x5

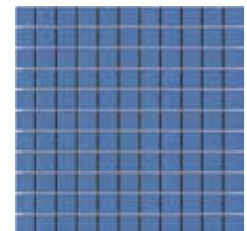

hydo mosaic blue 2.5x2.5

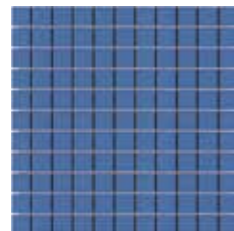

hydo mosaic dark blue 2.5x2.5

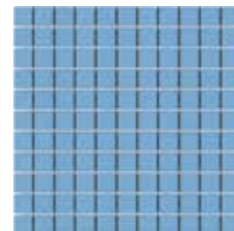

hydo mosaic sky blue 2.5x2.5

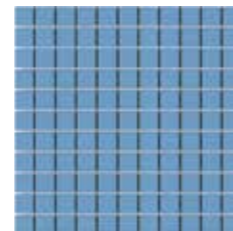

hydo mosaic medium blue 2.5x2.5

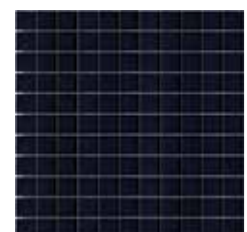

hydo mosaic navy blue 2.5x2.5

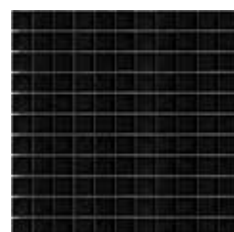

hydo mosaic black 2.5x2.5

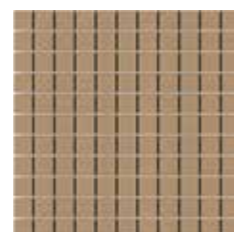

hydo mosaic dark beige 2.5x2.5

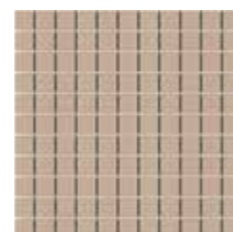

hydo mosaic beige 2.5x2.5

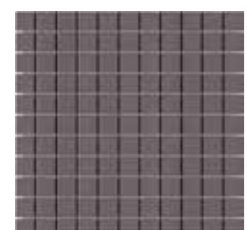

hydo mosaic dark grey 2.5x2.5

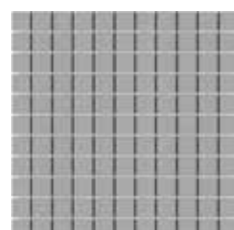

hydo mosaic grey 2.5x2.5

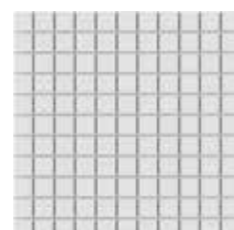

hydo mosaic white 2.5x2.5

## SIZES

mosaic 5x5  
31x31 cm  
12.2"x12.2"



mosaic 2.5x2.5  
29.7x29.7 cm  
11.69"x11.69"

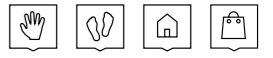

## FINISHES

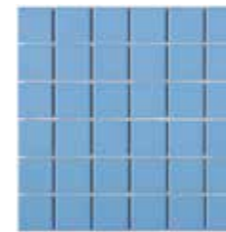

matt

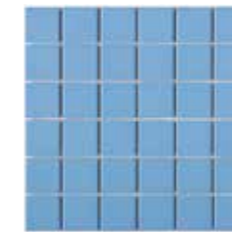

glossy

| Name                            | Code matt          | Code glossy        | Size(CM)  |
|---------------------------------|--------------------|--------------------|-----------|
| hydo mosaic beige 5x5           | AM2SHYDO-BEE.MoXoU | AM2SHYDO-BEE.HoXoU | 31x31     |
| hydo mosaic black 5x5           | AM2SHYDO-BLK.MoXoU | AM2SHYDO-BLK.HoXoU | 31x31     |
| hydo mosaic blue 5x5            | AM2SHYDO-BLE.MoXoU | AM2SHYDO-BLE.HoXoU | 31x31     |
| hydo mosaic dark beige 5x5      | AM2SHYDO-DBE.MoXoU | AM2SHYDO-DBE.HoXoU | 31x31     |
| hydo dark blue 5x5              | AM2SHYDO-DAB.MoXoU | AM2SHYDO-DAB.HoXoU | 31x31     |
| hydo mosaic dark grey 5x5       | AM2SHYDO-DKG.MoXoU | AM2SHYDO-DKG.HoXoU | 31x31     |
| hydo mosaic grey 5x5            | AM2SHYDO-GRY.MoXoU | AM2SHYDO-GRY.HoXoU | 31x31     |
| hydo mosaic medium blue 5x5     | AM2SHYDO-MEB.MoXoU | AM2SHYDO-MEB.HoXoU | 31x31     |
| hydo mosaic navy blue 5x5       | AM2SHYDO-NAY.MoXoU | AM2SHYDO-NAY.HoXoU | 31x31     |
| hydo mosaic sky blue 5x5        | AM2SHYDO-SKB.MoXoU | AM2SHYDO-SKB.HoXoU | 31x31     |
| hydo mosaic white 5x5           | AM2SHYDO-WHE.MoXoU | AM2SHYDO-WHE.HoXoU | 31x31     |
| hydo mosaic beige 2.5x2.5       | AM1SHYDO-BEE.MoXoU | AM1SHYDO-BEE.HoXoU | 29.7x29.7 |
| hydo mosaic black 2.5x2.5       | AM1SHYDO-BLK.MoXoU | AM1SHYDO-BLK.HoXoU | 29.7x29.7 |
| hydo mosaic blue 2.5x2.5        | AM1SHYDO-BLE.MoXoU | AM1SHYDO-BLE.HoXoU | 29.7x29.7 |
| hydo mosaic dark beige 2.5x2.5  | AM1SHYDO-DBE.MoXoU | AM1SHYDO-DBE.HoXoU | 29.7x29.7 |
| hydo mosaic dark blue 2.5x2.5   | AM1SHYDO-DAB.MoXoU | AM1SHYDO-DAB.HoXoU | 29.7x29.7 |
| hydo mosaic dark grey 2.5x2.5   | AM1SHYDO-DKG.MoXoU | AM1SHYDO-DKG.HoXoU | 29.7x29.7 |
| hydo mosaic grey 2.5x2.5        | AM1SHYDO-GRY.MoXoU | AM1SHYDO-GRY.HoXoU | 29.7x29.7 |
| hydo mosaic medium blue 2.5x2.5 | AM1SHYDO-MEB.MoXoU | AM1SHYDO-MEB.HoXoU | 29.7x29.7 |
| hydo mosaic navy blue 2.5x2.5   | AM1SHYDO-NAY.MoXoU | AM1SHYDO-NAY.HoXoU | 29.7x29.7 |
| hydo mosaic sky blue 2.5x2.5    | AM1SHYDO-SKB.MoXoU | AM1SHYDO-SKB.HoXoU | 29.7x29.7 |
| hydo mosaic white 2.5x2.5       | AM1SHYDO-WHE.MoXoU | AM1SHYDO-WHE.HoXoU | 29.7x29.7 |

# Swimming pool applications

## Special Pieces

Channel Plain



11.7x24.5 cm  
4.60"x9.64"



Available colours  
matt and glossy

Channel Hole

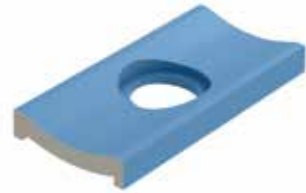

11.7x24.5 cm  
4.60"x9.64"



Available colours  
matt and glossy

Channel Edge



11.7x24.5 cm  
4.60"x9.64"



Available colours  
matt and glossy

GP Grills



24.5x24.5 cm  
9.64"x9.64"

L angle



30x60x8 cm  
11.81"x23.62"x3.14"

Step and Riser



30x120x15 cm  
11.81"x47.24"x5.90"

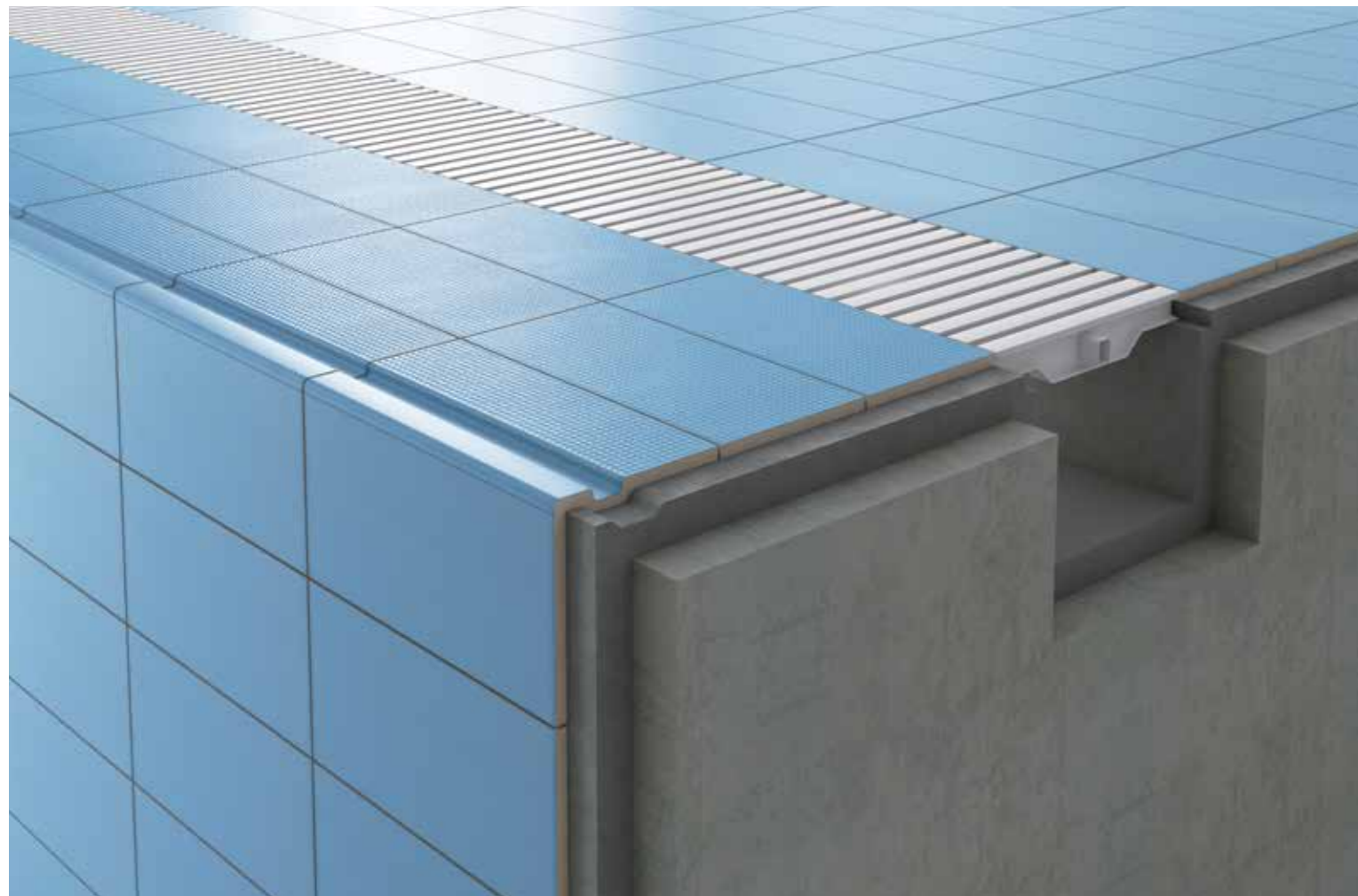





Wellness and swimming pools

# Porcelain tiles product range

## 20MM THICKNESS

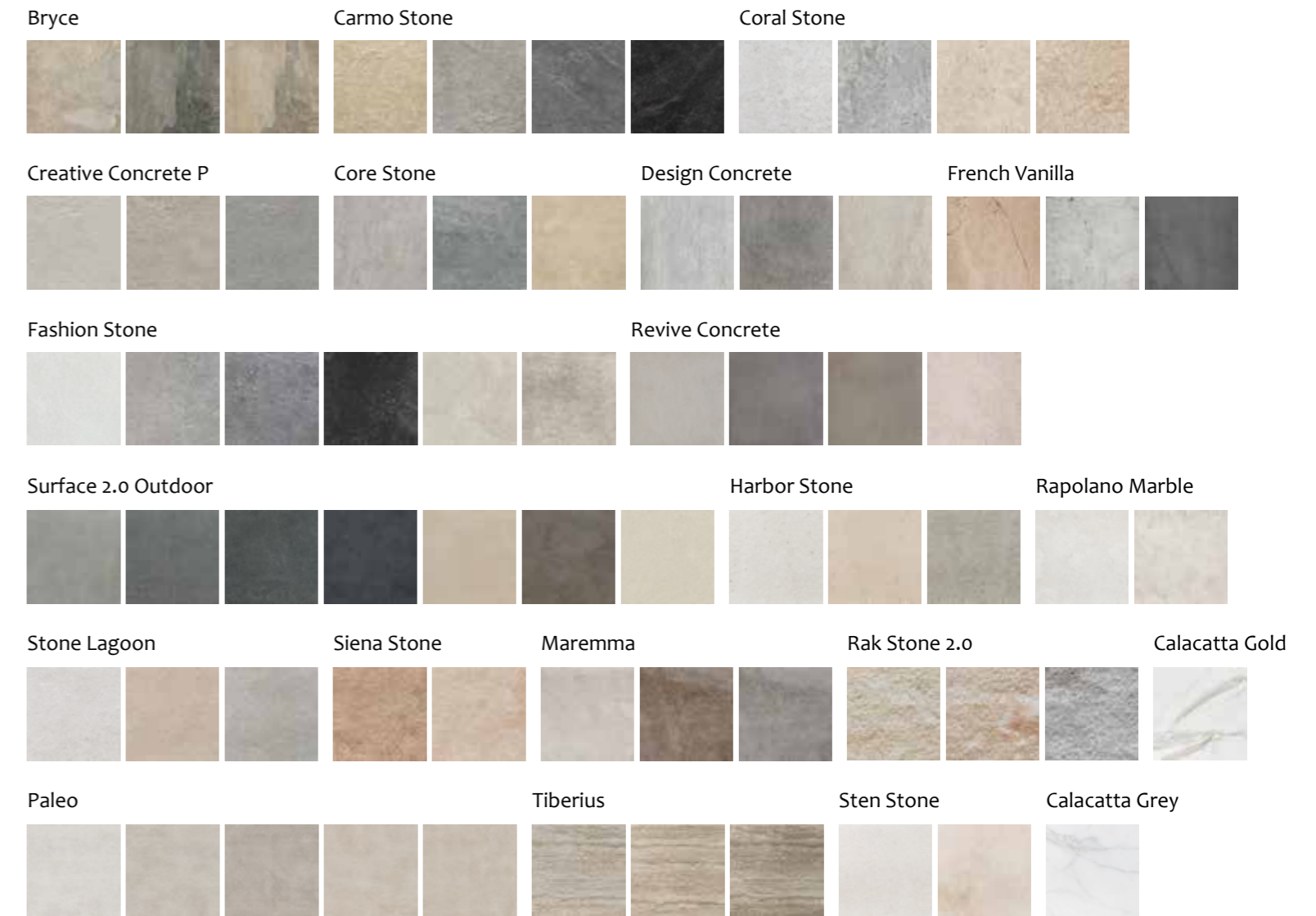

## HIGH PERFORMANCE TECHNICAL PRODUCTS BAREFOOT + ANTISLIP (A+B+C)

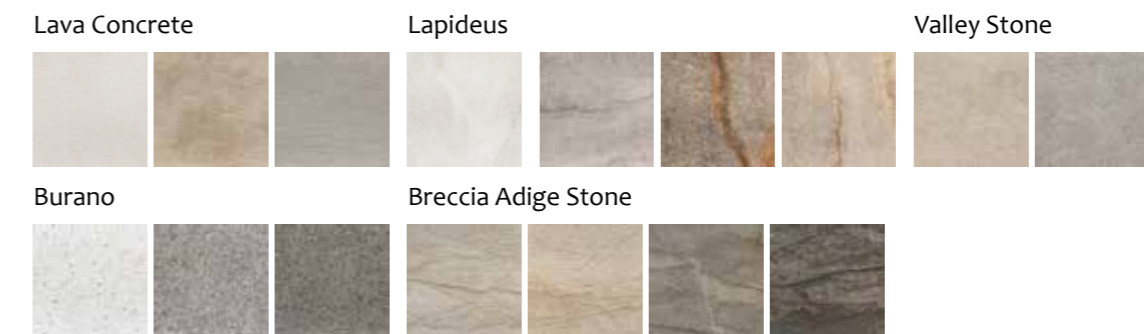

## PRODUCTS WITH R11 AND STANDARD THICKNESS

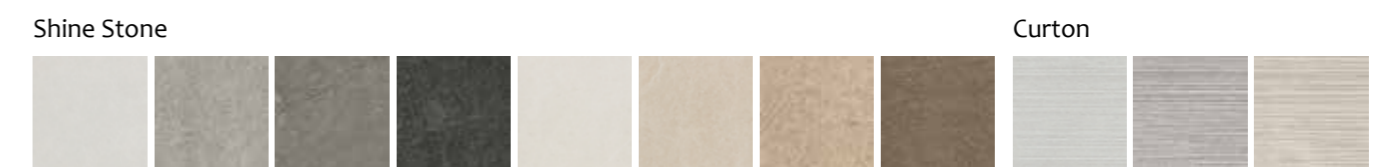

20mm thickness

# Bryce

PORCELAIN TILES

Matt • Rectified • Light Structure



bryce white

bryce anthracite

bryce gold

## Special Pieces



bryce special piece \*

bryce special piece left and right cut \*

bryce L shape \*

SIZES



\* Available in all colours

60x60 cm  
23.62"x23.62"

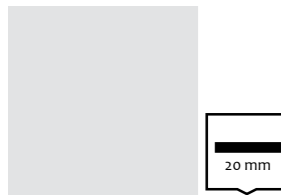

special pieces  
24.5x24.5 cm  
9.64"x9.64"



L shape  
30x60x8 cm  
11.81"x23.62"x3.14"



| Name             | Code               | Size(CM) | Name                            | Code               | Size(CM)  | Name                     | Code               | Size(CM) |
|------------------|--------------------|----------|---------------------------------|--------------------|-----------|--------------------------|--------------------|----------|
| bryce white      | Ao6GZBYC-WHO.M2T5R | 60x60    | bryce white special pieces      | AGWZZZBYCWHE005140 | 24.5x24.5 | bryce white L shape      | AGTZZZBYCWHE023521 | 30x60x8  |
| bryce anthracite | Ao6GZBYC-ANo.M2T5R | 60x60    | bryce anthracite special pieces | AGWZZZBYCANT005138 | 24.5x24.5 | bryce anthracite L shape | AGTZZZBYCANT023519 | 30x60x8  |
| bryce gold       | Ao6GZBYC-GLD.M2T5R | 60x60    | bryce gold special pieces       | AGWZZZBYCGOD005139 | 24.5x24.5 | bryce gold L shape       | AGTZZZBYCGLD023520 | 30x60x8  |

| Name                                     | Code               | Size(CM)  | Name                                      | Code               | Size(CM)  |
|--|--------------------|-----------|---|--------------------|-----------|
| bryce white special pieces left cut      | AGWZZZBYCWHE005182 | 24.5x24.5 | bryce white special pieces right cut      | AGWZZZBYCWHE005264 | 24.5x24.5 |
| bryce anthracite special pieces left cut | AGWZZZBYCANT005180 | 24.5x24.5 | bryce anthracite special pieces right cut | AGWZZZBYCANT005262 | 24.5x24.5 |
| bryce gold left special pieces cut       | AGWZZZBYCGOD005181 | 24.5x24.5 | bryce gold special pieces right cut       | AGWZZZBYCGOD005263 | 24.5x24.5 |

# Carmo Stone

PORCELAIN TILES

Matt • Rectified • Light Structure

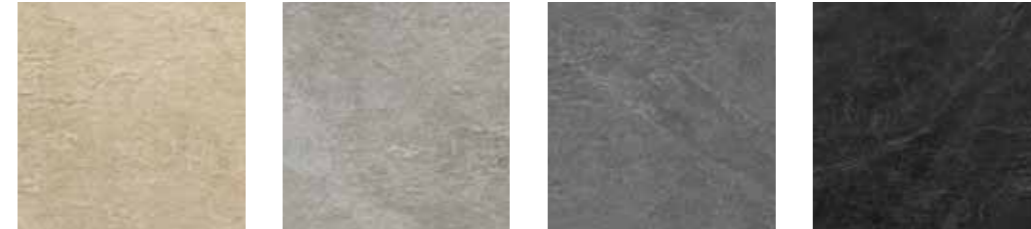

carmo stone ivory

carmo stone grey

carmo stone anthracite

carmo stone black

## Special Pieces

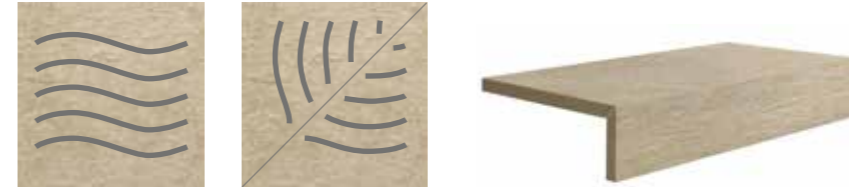

carmo stone special piece \*

carmo stone special piece left and right cut \*

carmo stone L shape \*

SIZES



\* Available in all colours

60x120 cm  
23.62"x47.24"

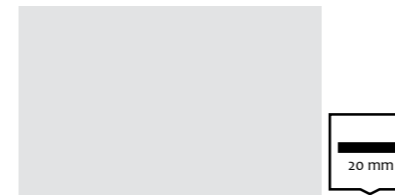

special pieces  
24.5x24.5 cm  
9.64"x9.64"



L shape  
30x120x8 cm  
11.81"x47.24"x3.14"



| Name                   | Code              | Size(CM) | Name                                  | Code              | Size(CM)  | Name                           | Code              | Size(CM) |
|------------------------|-------------------|----------|---------------------------------------|-------------------|-----------|--------------------------------|-------------------|----------|
| carmo stone anthracite | A12GCMO-ANT.Y6X7R | 60x60    | carmo stone anthracite special pieces | AGWZZCMOANT064198 | 24.5x24.5 | carmo stone anthracite L shape | AGTZZCMOANT064367 | 30x120x8 |
| carmo stone black      | A12GCMO-BLK.Y6X7R | 60x60    | carmo stone black special pieces      | AGWZZCMOBLK064199 | 24.5x24.5 | carmo stone black L shape      | AGTZZCMOBLK064368 | 30x120x8 |
| carmo stone grey       | A12GCMO-GRY.Y6X7R | 60x60    | carmo stone grey special pieces       | AGWZZCMOGRY064200 | 24.5x24.5 | carmo stone grey L shape       | AGTZZCMOGRY064369 | 30x120x8 |
| carmo stone ivory      | A12GCMO-IVO.Y6X7R | 60x60    | carmo stone ivory special pieces      | AGWZZCMOIVO064201 | 24.5x24.5 | carmo stone ivory L shape      | AGTZZCMOIVO064370 | 30x120x8 |

| Name   | Code              | Size(CM)  | Name                                       | Code              | Size(CM)  |
|--|-------------------|-----------|--|-------------------|-----------|
| carmo stone anthracite special pieces left cut | AGWZZCMOANT064216 | 24.5x24.5 | carmo stone anthracite pieces right cut    | AGWZZCMOANT063973 | 24.5x24.5 |
| carmo stone black special pieces left cut      | AGWZZCMOBLK064217 | 24.5x24.5 | carmo stone black special pieces right cut | AGWZZCMOBLK063974 | 24.5x24.5 |
| carmo stone grey left special pieces cut       | AGWZZCMOGRY064218 | 24.5x24.5 | carmo stone grey special pieces right cut  | AGWZZCMOGRY063975 | 24.5x24.5 |
| carmo stone ivory left special pieces cut      | AGWZZCMOIVO064219 | 24.5x24.5 | carmo stone ivory special pieces right cut | AGWZZCMOIVO063976 | 24.5x24.5 |

20mm thickness

# Coral Stone

PORCELAIN TILES  
Matt • Rectified • Light Structure



coral stone light grey coral stone grey coral stone ivory coral stone beige

## Special Pieces

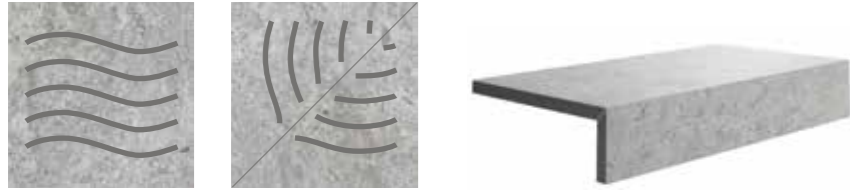

coral stone special piece \* coral stone special piece left and right cut \* coral stone L shape \*

SIZES



\* Available in all colours

60x60 cm  
23.62"x23.62"

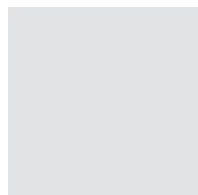

special pieces  
24.5x24.5 cm  
9.64"x9.64"



L shape  
30x60x8 cm  
11.81"x23.62"x3.14"

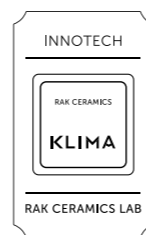

| Name                   | Code               | Size(CM) | Name                                  | Code               | Size(CM)  | Name                           | Code               | Size(CM) |
|------------------------|--------------------|----------|---------------------------------------|--------------------|-----------|--------------------------------|--------------------|----------|
| coral stone light grey | Ao6GCLNA-LGY.A6X7R | 60x60    | coral stone light grey special pieces | AGWZZCLNALIGo24559 | 24.5x24.5 | coral stone light grey L shape | AGWZZCLNALIGo24961 | 30x60x8  |
| coral stone grey       | Ao6GCLNA-GRY.A6X7R | 60x60    | coral stone grey special pieces       | AGWZZCLNAGRYo24553 | 24.5x24.5 | coral stone grey L shape       | AGWZZCLNAGRYo24955 | 30x60x8  |
| coral stone ivory      | Ao6GCLNA-IVO.A6X7R | 60x60    | coral stone ivory special pieces      | AGWZZCLNAIVOo24556 | 24.5x24.5 | coral stone ivory L shape      | AGWZZCLNAIVOo24958 | 30x60x8  |
| coral stone beige      | Ao6GCLNA-BEE.A6X7R | 60x60    | coral stone beige special pieces      | AGWZZCLNABEEo24550 | 24.5x24.5 | coral stone beige L shape      | AGWZZCLNABEEo24952 | 30x60x8  |

| Name   | Code               | Size(CM)  | Name  | Code               | Size(CM)  |
|--|--------------------|-----------|---|--------------------|-----------|
| coral stone light grey special pieces left cut | AGWZZCLNALIGo24929 | 24.5x24.5 | coral stone light grey special pieces right cut | AGWZZCLNALIGo24901 | 24.5x24.5 |
| coral stone grey special pieces left cut       | AGWZZCLNAGRYo24923 | 24.5x24.5 | coral stone grey special pieces right cut       | AGWZZCLNAGRYo24895 | 24.5x24.5 |
| coral stone ivory special pieces left cut      | AGWZZCLNAIVOo24926 | 24.5x24.5 | coral stone ivory special pieces right cut      | AGWZZCLNAIVOo24898 | 24.5x24.5 |
| coral stone beige special pieces left cut      | AGWZZCLNABEEo24920 | 24.5x24.5 | coral stone beige special pieces right cut      | AGWZZCLNABEEo24892 | 24.5x24.5 |

# Core Stone

PORCELAIN TILES  
Matt • Rectified • Light Structure



core stone grey core stone anthracite core stone beige

## Special Pieces

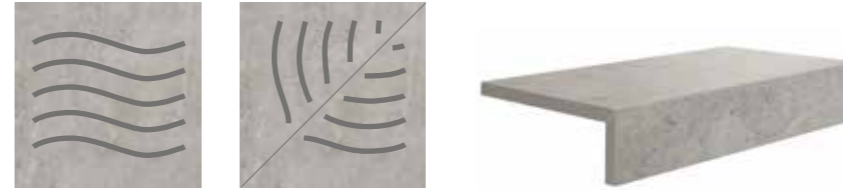

core stone special piece \* core stone special piece left and right cut \* core stone L shape \*

SIZES



\* Available in all colours

60x60 cm  
23.62"x23.62"

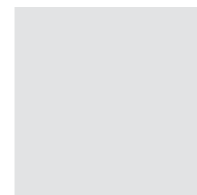

special pieces  
24.5x24.5 cm  
9.64"x9.64"



L shape  
30x60x8 cm  
11.81"x23.62"x3.14"



| Name                  | Code               | Size(CM) | Name                                 | Code              | Size(CM)  | Name                          | Code              | Size(CM) |
|-----------------------|--------------------|----------|--------------------------------------|-------------------|-----------|-------------------------------|-------------------|----------|
| core stone grey       | Ao6GZCES-GYo.MoT5R | 60x60    | core stone grey special pieces       | AGWZZCESGRY005145 | 24.5x24.5 | core stone grey L shape       | AGTZZCESGRY023522 | 30x60x8  |
| core stone anthracite | Ao6GZCES-ANo.MoT5R | 60x60    | core stone anthracite special pieces | AGWZZCESANT005146 | 24.5x24.5 | core stone anthracite L shape | AGTZZCESANT023523 | 30x60x8  |
| core stone beige      | Ao6GZCES-BEo.MoT5R | 60x60    | core stone beige special pieces      | AGWZZCESBEE005147 | 24.5x24.5 | core stone beige L shape      | AGTZZCESBEE023524 | 30x60x8  |

| Name  | Code              | Size(CM)  | Name   | Code              | Size(CM)  |
|---|-------------------|-----------|--|-------------------|-----------|
| core stone grey special pieces left cut       | AGWZZCESGRY005186 | 24.5x24.5 | core stone grey special pieces right cut       | AGWZZCESGRY005268 | 24.5x24.5 |
| core stone anthracite special pieces left cut | AGWZZCESANT005187 | 24.5x24.5 | core stone anthracite special pieces right cut | AGWZZCESANT005269 | 24.5x24.5 |
| core stone beige special pieces left cut      | AGWZZCESBEE005188 | 24.5x24.5 | core stone beige special pieces right cut      | AGWZZCESBEE005270 | 24.5x24.5 |

20mm thickness

# Creative Concrete P

PORCELAIN TILES

Matt • Rectified • Light Structure



creative concrete p dark grey   creative concrete p grey   creative concrete p white

## SIZES



60x120 cm  
23.62"x47.24"

\* Available in all colours

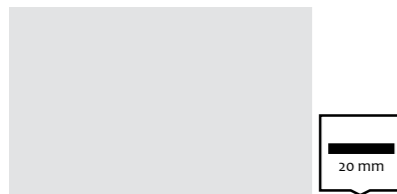

| Name                          | Code               | Size(CM) |
|-------------------------------|--------------------|----------|
| creative concrete p dark grey | A12GCTVP-DKG.YDX7R | 60x120   |
| creative concrete p grey      | A12GCTVP-GRY.YDX7R | 60x60    |
| creative concrete p white     | A12GCTVP-WHE.YDX7R | 60x60    |

| Name   | Code                | Size(CM)  | Name  | Code                | Size(CM)  |
|--|---------------------|-----------|---|---------------------|-----------|
| design concrete light grey special pieces          | AGWZZZDCCLIG005151  | 24.5x24.5 | design concrete light grey L shape                  | AGTZZZDCCCLGY023509 | 30x60x8   |
| design concrete dark grey special pieces           | AGWZZZDCCDKG005149  | 24.5x24.5 | design concrete dark grey L shape                   | AGTZZZDCCDGY023507  | 30x60x8   |
| design concrete ivory special pieces               | AGWZZZDCCIVO005150  | 24.5x24.5 | design concrete ivory L shape                       | AGTZZZDCCIVO023508  | 30x60x8   |
| design concrete light grey special pieces left cut | AGWZZZDCCCLIG005192 | 24.5x24.5 | design concrete light grey special pieces right cut | AGWZZZDCCCLIG005256 | 24.5x24.5 |
| design concrete dark grey special pieces left cut  | AGWZZZDCCDKG005190  | 24.5x24.5 | design concrete dark grey special pieces right cut  | AGWZZZDCCDKG005254  | 24.5x24.5 |
| design concrete ivory special pieces left cut      | AGWZZZDCCIVO005191  | 24.5x24.5 | design concrete ivory special pieces right cut      | AGWZZZDCCIVO005255  | 24.5x24.5 |

# Design Concrete

PORCELAIN TILES

Matt • Rectified • Heavy Structure



design concrete light grey   design concrete dark grey   design concrete ivory

## Mosaic

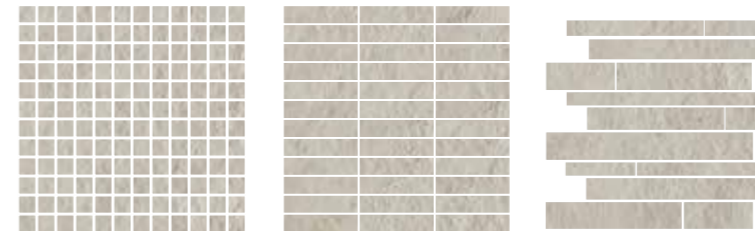

design concrete mosaic 2.5x2.5\*   design concrete mosaic 2.5x10\*   design concrete brick mosaic\*

## Special Pieces

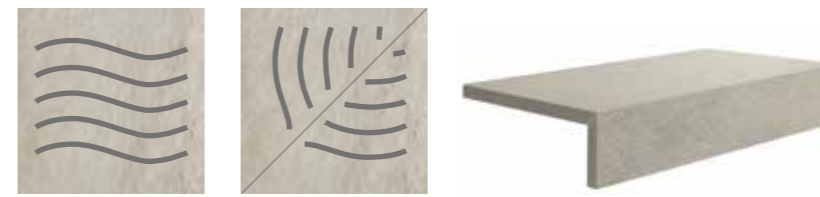

design concrete special piece \*   design concrete special piece left and right cut \*   design concret L shape \*

## SIZES



60x60 cm  
23.62"x23.62"

\* Available in all colours

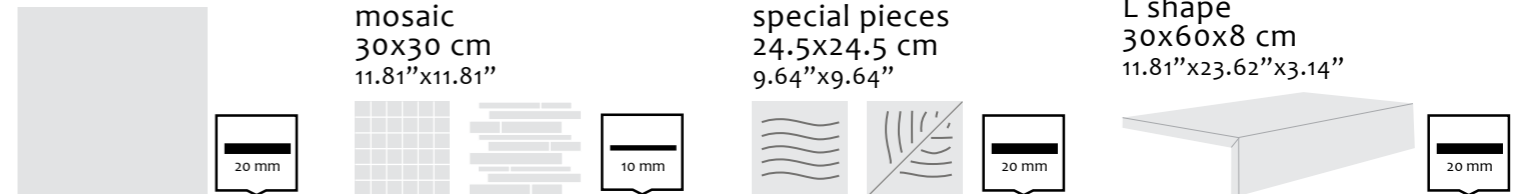

| Name                                      | Code               | Size(CM) | Name                                     | Code               | Size(CM) |
|---|--------------------|----------|--|--------------------|----------|
| design concrete light grey                | Ao6GZDCC-LGY.M2T5R | 60x60    | design concrete light grey brick mosaic  | AM-GZDCC-LG.2R/BRK | 30x30    |
| design concrete dark grey                 | Ao6GZDCC-DGY.M2T5R | 60x60    | design concrete dark grey brick mosaic   | AM-GZDCC-DG.2R/BRK | 30x30    |
| design concrete ivory                     | Ao6GZDCC-IVo.M2T5R | 60x60    | design concrete ivory brick mosaic       | AM-GZDCC-IV.2R/BRK | 30x30    |
| design concrete light grey mosaic 2.5x2.5 | AM-GZDCC-LGY.2R/2H | 30x30    | design concrete light grey mosaic 2.5x10 | AM-GZDCC-LG.2R2/10 | 30x30    |
| design concrete dark grey mosaic 2.5x2.5  | AM-GZDCC-DG.2R/2H  | 30x30    | design concrete dark grey mosaic 2.5x10  | AM-GZDCC-DG.2R2/10 | 30x30    |
| design concrete ivory mosaic 2.5x2.5      | AM-GZDCC-IV.2R/2H  | 30x30    | design concrete ivory mosaic 2.5x10      | AM-GZDCC-IV.2R2/10 | 30x30    |

20mm thickness

# French Vanilla

PORCELAIN TILES

Matt • Rectified • Smooth



french vanilla beige



french vanilla grey



french vanilla anthracite

## Special Pieces



french vanilla special piece \*



french vanilla special piece left and right cut \*



french vanilla L shape \*

## SIZES



\* Available in all colours

60x60 cm  
23.62"x23.62"

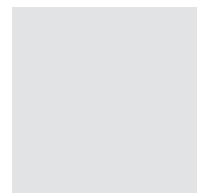

special pieces  
24.5x24.5 cm  
9.64"x9.64"



L shape  
30x60x8 cm  
11.81"x23.62"x3.14"



| Name                      | Code              | Size(CM) | Name                                     | Code              | Size(CM)  | Name                              | Code              | Size(CM) |
|---------------------------|-------------------|----------|--|-------------------|-----------|-----------------------------------|-------------------|----------|
| french vanilla anthracite | Ao6GFRE-ANo.MoT5R | 60x60    | french vanilla anthracite special pieces | AGWZZFREANTo63960 | 24.5x24.5 | french vanilla anthracite L shape | AGTZZFREANTo63929 | 30x60x8  |
| french vanilla beige      | Ao6GFRE-BEo.MoT5R | 60x60    | french vanilla beige special pieces      | AGWZZFREBEo63961  | 24.5x24.5 | french vanilla beige L shape      | AGTZZFREBEo63930  | 30x60x8  |
| french vanilla grey       | Ao6GFRE-GYo.MoT5R | 60x60    | french vanilla grey special pieces       | AGWZZFREGRYo63962 | 24.5x24.5 | french vanilla grey white L shape | AGTZZFREGRYo63931 | 30x60x8  |

| Name  | Code              | Size(CM)  | Name  | Code              | Size(CM)  |
|---|-------------------|-----------|---|-------------------|-----------|
| french vanilla anthracite special pieces left cut | AGWZZFREANTo63998 | 24.5x24.5 | french vanilla anthracite pieces right cut    | AGWZZFREANTo64008 | 24.5x24.5 |
| french vanilla beige special pieces left cut      | AGWZZFREBEo63999  | 24.5x24.5 | french vanilla beige special pieces right cut | AGWZZFREBEo64009  | 24.5x24.5 |
| french vanilla grey special pieces cut            | AGWZZFREGRYo64000 | 24.5x24.5 | french vanilla grey special pieces right cut  | AGWZZFREGRYo64010 | 24.5x24.5 |

# Fashion Stone

PORCELAIN TILES

Matt • Rectified • Light Structure



fashion stone ivory



fashion stone light grey



fashion stone grey



fashion stone black



fashion stone beige



fashion stone clay

## Special Pieces

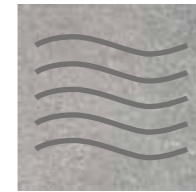

fashion stone special piece \*

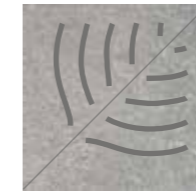

fashion stone special piece left and right cut \*



fashion stone L shape \*

## SIZES



\* Available in all colours

60x60 cm  
23.62"x23.62"

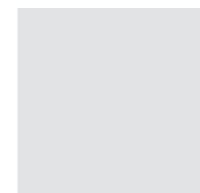

special pieces  
24.5x24.5 cm  
9.64"x9.64"



L shape  
30x60x8 cm  
11.81"x23.62"x3.14"



| Name                     | Code               | Size(CM) | Name                                    | Code               | Size(CM)  | Name                             | Code               | Size(CM) |
|--------------------------|--------------------|----------|---|--------------------|-----------|----------------------------------|--------------------|----------|
| fashion stone light grey | Ao6GFNSE-LIG.MYX7R | 60x60    | fashion stone light grey special pieces | AGWZZFNSELIGo23346 | 24.5x24.5 | fashion stone light grey L shape | AGTZZFNSELIGo23505 | 30x60x8  |
| fashion stone grey       | Ao6GFNSE-GRY.MYX7R | 60x60    | fashion stone grey special pieces       | AGWZZFNSEGRYo23343 | 24.5x24.5 | fashion stone grey L shape       | AGTZZFNSEGRYo23502 | 30x60x8  |
| fashion stone black      | Ao6GFNSE-BLK.MYX7R | 60x60    | fashion stone black special pieces      | AGWZZFNSEBLKo23345 | 24.5x24.5 | fashion stone black L shape      | AGTZZFNSEBLKo23504 | 30x60x8  |
| fashion stone ivory      | Ao6GFNSE-IVO.MYX7R | 60x60    | fashion stone ivory special pieces      | AGWZZFNSEIVOo23344 | 24.5x24.5 | fashion stone ivory L shape      | AGTZZFNSEIVOo23503 | 30x60x8  |
| fashion stone beige      | Ao6GFNSE-BEE.MYX7R | 60x60    | fashion stone beige special pieces      | AGWZZFNSEBEEo23341 | 24.5x24.5 | fashion stone beige L shape      | AGTZZFNSEBEEo23500 | 30x60x8  |
| fashion stone clay       | Ao6GFNSE-CLA.MYX7R | 60x60    | fashion stone clay special pieces       | AGWZZFNSECLAo23342 | 24.5x24.5 | fashion stone clay L shape       | AGTZZFNSECLAo23501 | 30x60x8  |

| Name   | Code               | Size(CM)  | Name  | Code               | Size(CM)  |
|--|--------------------|-----------|---|--------------------|-----------|
| fashion stone light grey special pieces left cut | AGWZZFNSELIGo23332 | 24.5x24.5 | fashion stone light grey special pieces right cut | AGWZZFNSELIGo23338 | 24.5x24.5 |
| fashion stone grey special pieces left cut       | AGWZZFNSEGRYo23349 | 24.5x24.5 | fashion stone grey special pieces right cut       | AGWZZFNSEGRYo23335 | 24.5x24.5 |
| fashion stone black special pieces left cut      | AGWZZFNSEBLKo23331 | 24.5x24.5 | fashion stone black special pieces right cut      | AGWZZFNSEBLKo23336 | 24.5x24.5 |
| fashion stone ivory special pieces left cut      | AGWZZFNSEIVOo23350 | 24.5x24.5 | fashion stone ivory special pieces right cut      | AGWZZFNSEIVOo23337 | 24.5x24.5 |
| fashion stone beige special pieces left cut      | AGWZZFNSEBEEo23347 | 24.5x24.5 | fashion stone beige special pieces right cut      | AGWZZFNSEBEEo23333 | 24.5x24.5 |
| fashion stone clay special pieces left cut       | AGWZZFNSECLAo23348 | 24.5x24.5 | fashion stone clay special pieces right cut       | AGWZZFNSECLAo23334 | 24.5x24.5 |

20mm thickness

# Revive Concrete

PORCELAIN TILES  
Matt • Rectified • Light Structure



revive concrete active white   revive concrete concrete grey   revive concrete cloud grey   revive concrete summer sand

## Mosaic



revive concrete mosaic 5x5 \*   revive concrete mix 1   revive concrete mix 2

## Special Pieces

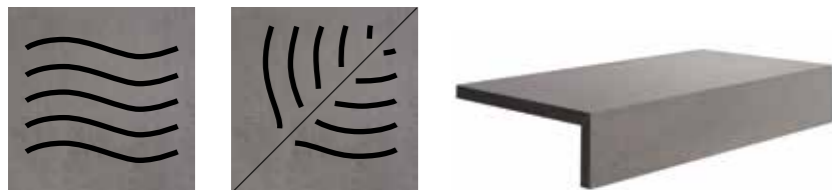

revive concrete special piece \*   revive concrete special piece left and right cut \*   revive concrete L shape \*

## SIZES

60x60 cm  
23.62"x23.62"

mosaic  
30x30 cm  
11.81"x11.81"

special pieces  
24.5x24.5 cm  
9.64"x9.64"

L shape  
30x60x8 cm  
11.81"x23.62"x3.14"

\* Available in all colours

# Surface 2.0 Outdoor

PORCELAIN TILES  
Matt • Rectified • Smooth

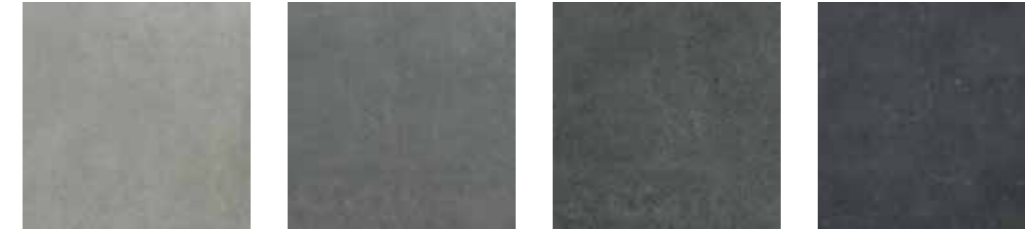

surface 2.0 outdoor cool grey   surface 2.0 outdoor mid grey   surface 2.0 outdoor ash   surface 2.0 outdoor night



surface 2.0 outdoor sand   surface 2.0 outdoor copper   surface 2.0 outdoor off white

## Mosaic

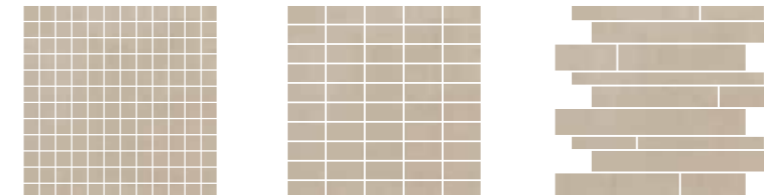

surface 2.0 mosaic 2.3x2.3 \*   surface 2.0 mosaic 2.7x5.8 \*   surface 2.0 brick mosaic \*

## Special Pieces



surface 2.0 special piece \*   surface 2.0 special piece left and right cut \*   surface 2.0 L shape \*

## SIZES

60x60 cm  
23.62"x23.62"

mosaic  
30x30 cm  
11.81"x11.81"

special pieces  
24.5x24.5 cm  
9.64"x9.64"

L shape  
30x60x8 cm  
11.81"x23.62"x3.14"

\* Available in all colours

20mm thickness

| Name  | Code               | Size(CM)  | Name   | Code               | Size(CM)  |
|---|--------------------|-----------|--|--------------------|-----------|
| revive concrete active white                          | AGBo6REVCACWZMLT5R | 60X60     | revive concrete active white special pieces            | AGWZZREVCACW005123 | 24.5X24.5 |
| revive concrete concrete grey                         | AGBo6REVCCRGZMLT5R | 60X60     | revive concrete concrete grey special pieces           | AGWZZREVCCRG005127 | 24.5X24.5 |
| revive concrete cloud grey                            | AGBo6REVCCGYZMLT5R | 60X60     | revive concrete cloud grey special pieces              | AGWZZREVCCLG005126 | 24.5X24.5 |
| revive concrete summer sand                           | AGBo6REVCSMSZMLT5R | 60X60     | revive concrete summer sand special pieces             | AGWZZREVCSMS005128 | 24.5X24.5 |
| revive concrete active white special pieces left cut  | AGWZZREVCACW005160 | 24.5X24.5 | revive concrete active white special pieces right cut  | AGWZZREVCACW005273 | 24.5X24.5 |
| revive concrete concrete grey special pieces left cut | AGWZZREVCCRG005164 | 24.5X24.5 | revive concrete concrete grey special pieces right cut | AGWZZREVCCRG005277 | 24.5X24.5 |
| revive concrete cloud grey special pieces left cut    | AGWZZREVCCLG005163 | 24.5X24.5 | revive concrete cloud grey special pieces right cut    | AGWZZREVCCLG005276 | 24.5X24.5 |
| revive concrete summer sand special pieces left cut   | AGWZZREVCSMS005165 | 24.5X24.5 | revive concrete summer sand special pieces right cut   | AGWZZREVCSMS005278 | 24.5X24.5 |
| revive concrete active white mosaic 5x5               | AGM84REVCACWZMSNLR | 30X30     | revive concrete active white L shape                   | AGWZZREVCACW005123 | 30x60x8   |
| revive concrete concrete grey mosaic 5x5              | AGM84REVCCRGZMSNLR | 30X30     | revive concrete concrete grey L shape                  | AGWZZREVCCRG005127 | 30x60x8   |
| revive concrete cloud grey mosaic 5x5                 | AGM84REVCCGYZMSNLR | 30X30     | revive concrete cloud grey L shape                     | ACTZZREVCCRG023531 | 30x60x8   |
| revive concrete summer sand mosaic 5x5                | AGM84REVCSMSZMSNLR | 30X30     | revive concrete summer sand L shape                    | AGWZZREVCSMS005128 | 30x60x8   |
| revive concrete mix 1 mosaic 3x6                      | AGM85REVCMX1ZMSNLR | 30X30     |  |                    |           |
| revive concrete mix 2 mosaic 3x6                      | AGM85REVCMX2ZMSNLR | 30X30     |  |                    |           |

| Name                          | Code               | Size(CM) | Name                                       | Code               | Size(CM) |
|-------------------------------|--------------------|----------|--|--------------------|----------|
| surface 2.0 outdoor cool grey | Ao6GZSUR-CGY.MoT5R | 60x60    | surface 2.0 outdoor cool grey brick mosaic | AM-GZSUR-CG.RT/BRK | 30x30    |
| surface 2.0 outdoor mid grey  | Ao6GZSUR-MGY.MoT5R | 60x60    | surface 2.0 outdoor mid grey brick mosaic  | AM-GZSUR-MG.RT/BRK | 30x30    |
| surface 2.0 outdoor ash       | Ao6GZSUR-ASo.MoT5R | 60x60    | surface 2.0 outdoor ash brick mosaic       | AM-GZSUR-AS.RT/BRK | 30x30    |
| surface 2.0 outdoor night     | Ao6GZSUR-NTo.MoT5R | 60x60    | surface 2.0 outdoor night brick mosaic     | AM-GZSUR-NT.RT/BRK | 30x30    |
| surface 2.0 outdoor sand      | Ao6GZSUR-SNo.MoT5R | 60x60    | surface 2.0 outdoor sand brick mosaic      | AM-GZSUR-SN.RT/BRK | 30x30    |
| surface 2.0 outdoor copper    | Ao6GZSUR-CPo.MoT5R | 60x60    | surface 2.0 outdoor copper brick mosaic    | AM-GZSUR-CP.RT/BRK | 30x30    |
| surface 2.0 outdoor off-white | Ao6GZSUR-OWH.MoT5R | 60x60    | surface 2.0 outdoor off-white brick mosaic | AM-GZSUR-OW.RT/BRK | 30x30    |

|  |                   |       |  |                   |       |
|--|-------------------|-------|--|-------------------|-------|
| surface 2.0 outdoor cool grey mosaic 2.3x2.3 | AM-GZSUR-CG.RT/2H | 30x30 | surface 2.0 outdoor cool grey mosaic 2.7x5.8 | AM-GZSUR-CG.RT3/6 | 30x30 |
| surface 2.0 outdoor mid grey mosaic 2.3x2.3  | AM-GZSUR-MG.RT/2H | 30x30 | surface 2.0 outdoor mid grey mosaic 2.7x5.8  | AM-GZSUR-MG.RT3/6 | 30x30 |
| surface 2.0 outdoor ash mosaic 2.3x2.3       | AM-GZSUR-AS.RT/2H | 30x30 | surface 2.0 outdoor ash mosaic 2.7x5.8       | AM-GZSUR-AS.RT3/6 | 30x30 |
| surface 2.0 outdoor night mosaic 2.3x2.3     | AM-GZSUR-NT.RT/2H | 30x30 | surface 2.0 outdoor night mosaic 2.7x5.8     | AM-GZSUR-NT.RT3/6 | 30x30 |
| surface 2.0 outdoor sand mosaic 2.3x2.3      | AM-GZSUR-SN.RT/2H | 30x30 | surface 2.0 outdoor sand mosaic 2.7x5.8      | AM-GZSUR-SN.RT3/6 | 30x30 |
| surface 2.0 outdoor copper mosaic 2.3x2.3    | AM-GZSUR-CP.RT/2H | 30x30 | surface 2.0 outdoor copper mosaic 2.7x5.8    | AM-GZSUR-CP.RT3/6 | 30x30 |
| surface 2.0 outdoor off-white mosaic 2.3x2.3 | AM-GZSUR-OW.RT/2H | 30x30 | surface 2.0 outdoor off-white mosaic 2.7x5.8 | AM-GZSUR-OW.RT3/6 | 30x30 |

|  |                   |           |                                       |                   |         |
|--|-------------------|-----------|---------------------------------------|-------------------|---------|
| surface 2.0 outdoor cool grey special pieces | AGWZZSURCGY005132 | 24.5X24.5 | surface 2.0 outdoor cool grey L shape | AGTZZSURCGY023535 | 30x60x8 |
| surface 2.0 outdoor mid grey special pieces  | AGWZZSURMGY005134 | 24.5X24.5 | surface 2.0 outdoor mid grey L shape  | AGTZZSURMGY023536 | 30x60x8 |
| surface 2.0 outdoor ash special pieces       | AGWZZSURASH005129 | 24.5X24.5 | surface 2.0 outdoor ash L shape       | AGTZZSURASH023533 | 30x60x8 |
| surface 2.0 outdoor night special pieces     | AGWZZSURNIT005130 | 24.5X24.5 | surface 2.0 outdoor night L shape     | AGWZZSURNIT024028 | 30x60x8 |
| surface 2.0 outdoor sand special pieces      | AGWZZSURSND005135 | 24.5X24.5 | surface 2.0 outdoor sand L shape      | AGTZZSURSND023537 | 30x60x8 |
| surface 2.0 outdoor copper special pieces    | AGWZZSURCOP005133 | 24.5X24.5 | surface 2.0 outdoor copper L shape    | AGWZZSURCOP024027 | 30x60x8 |
| surface 2.0 outdoor off-white special pieces | AGWZZSUROWH064438 | 24.5X24.5 | surface 2.0 outdoor off-white L shape | AGTZZSUROWH064049 | 30x60x8 |

|   |                   |           |  |                   |           |
|---|-------------------|-----------|--|-------------------|-----------|
| surface 2.0 outdoor cool grey special pieces left cut | AGWZZSURCGY005174 | 24.5X24.5 | surface 2.0 outdoor cool grey special pieces right cut | AGWZZSURCGY005292 | 24.5X24.5 |
| surface 2.0 outdoor mid grey special pieces left cut  | AGWZZSURMGY005176 | 24.5X24.5 | surface 2.0 outdoor mid grey special pieces right cut  | AGWZZSURMGY005294 | 24.5X24.5 |
| surface 2.0 outdoor ash special pieces left cut       | AGWZZSURASH005171 | 24.5X24.5 | surface 2.0 outdoor ash special pieces right cut       | AGWZZSURASH005279 | 24.5X24.5 |
| surface 2.0 outdoor night special pieces left cut     | AGWZZSURNIT064044 | 24.5X24.5 | surface 2.0 outdoor night special pieces right cut     | AGWZZSURNIT064034 | 24.5X24.5 |
| surface 2.0 outdoor sand special pieces left cut      | AGWZZSURSND005177 | 24.5X24.5 | surface 2.0 outdoor sand special pieces right cut      | AGWZZSURSND005295 | 24.5X24.5 |
| surface 2.0 outdoor copper special pieces left cut    | AGWZZSURCOP064043 | 24.5X24.5 | surface 2.0 outdoor copper special pieces right cut    | AGWZZSURCOP064033 | 24.5X24.5 |
| surface 2.0 outdoor off-white special pieces left cut | AGWZZSUROWH064045 | 24.5X24.5 | surface 2.0 outdoor off-white special pieces right cut | AGWZZSUROWH064035 | 24.5X24.5 |



20mm thickness

60x120 Outdoor

# 60x120 Outdoor

PORCELAIN TILES

Matt • Rectified • Smooth / Light Structure

## harbor stone



harbor stone ivory light structure



harbor stone beige light structure



harbor stone grey light structure

## rapalano marble



rapalano marble light beige smooth



rapalano marble beige smooth

## calacatta gold



calacatta gold white smooth



calacatta grey white smooth

## maremma



maremma sand light structure



maremma copper light structure



maremma grey light structure

## rak stone 2.0



rak stone 2.0 gold light structure



rak stone 2.0 natural light structure



rak stone 2.0 grey light structure

## stone lagoon



stone lagoon light grey light structure



stone lagoon sand light structure



stone lagoon grey light structure

## tiberius



tiberius ivory light structure



tiberius beige light structure



tiberius light brown light structure

KLIMA is not applicable for Maremma and Paleo

## SIZES

60x120 cm  
23.62"x47.24"

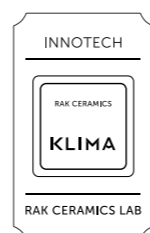
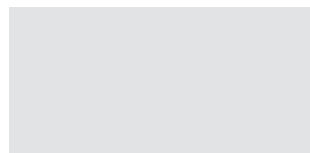

| Name                  | Code               | Name                        | Code               | Name                    | Code               | Size(CM) |
|-----------------------|--------------------|-----------------------------|--------------------|-------------------------|--------------------|----------|
| harbor stone beige    | A12GHBSN-BEE.Y6X7R | calacatta gold white        | A12GGDCL-WHE.YoX7R | paleo beige             | A12GPAEO-BEE.YoX7R | 60x120   |
| harbor stone grey     | A12GHBSN-GRY.Y6X7R | calacatta grey white        | A12GGRCL-WHE.YoX7R | paleo clay              | A12GPAEO-CLA.YoX7R | 60x120   |
| harbor stone ivory    | A12GHBSN-IVO.Y6X7R | rapalano marble beige       | A12GRLMB-BEE.YoX7R | paleo grey              | A12GPAEO-GRY.YoX7R | 60x120   |
| maremma copper        | A12GMRMA-COP.Y6X7R | rapalano marble light beige | A12GRLMB-LBE.YoX7R | paleo warm grey         | A12GPAEO-WGY.YoX7R | 60x120   |
| maremma grey          | A12GMRMA-GRY.Y6X7R | sienna stone beige          | A12GSNNE-BEE.Y6X7R | paleo white             | A12GPAEO-WHE.YoX7R | 60x120   |
| maremma sand          | A12GMRMA-SND.Y6X7R | sienna stone deep sand      | A12GSNNE-DES.Y6X7R | stone lagoon grey       | A12GSNOG-GRY.Y6X7R | 60x120   |
| rak stone 2.0 gold    | A12GRTOE-GOD.Y6X7R | tiberius beige              | A12GTEBR-BEE.YoX7R | stone lagoon light grey | A12GSNOG-LIG.Y6X7R | 60x120   |
| rak stone 2.0 grey    | A12GRTOE-GRY.Y6X7R | tiberius ivory              | A12GTEBR-IVO.YoX7R | stone lagoon sand       | A12GSNOG-SND.Y6X7R | 60x120   |
| rak stone 2.0 natural | A12GRTOE-NUR.Y6X7R | tiberius light brown        | A12GTEBR-LBR.YoX7R | sten stone ivory        | A12GSNSE-IVO.YoX7R | 60x120   |
|                       |                    |                             |                    | sten stone white        | A12GSNSE-WHE.YoX7R | 60x120   |



20mm thickness

60x120 Outdoor

# 60x120 Outdoor

PORCELAIN TILES  
Matt • Rectified • Smooth / Light Structure

## paleo



paleo white smooth



paleo warm grey smooth



paleo grey smooth



paleo clay smooth



paleo beige smooth

## siena stone



siena stone deep sand light structure



siena stone beige light structure

## sten stone



sten stone white light structure



sten stone ivory light structure

### SIZES

60x120 cm  
23.62"x47.24"

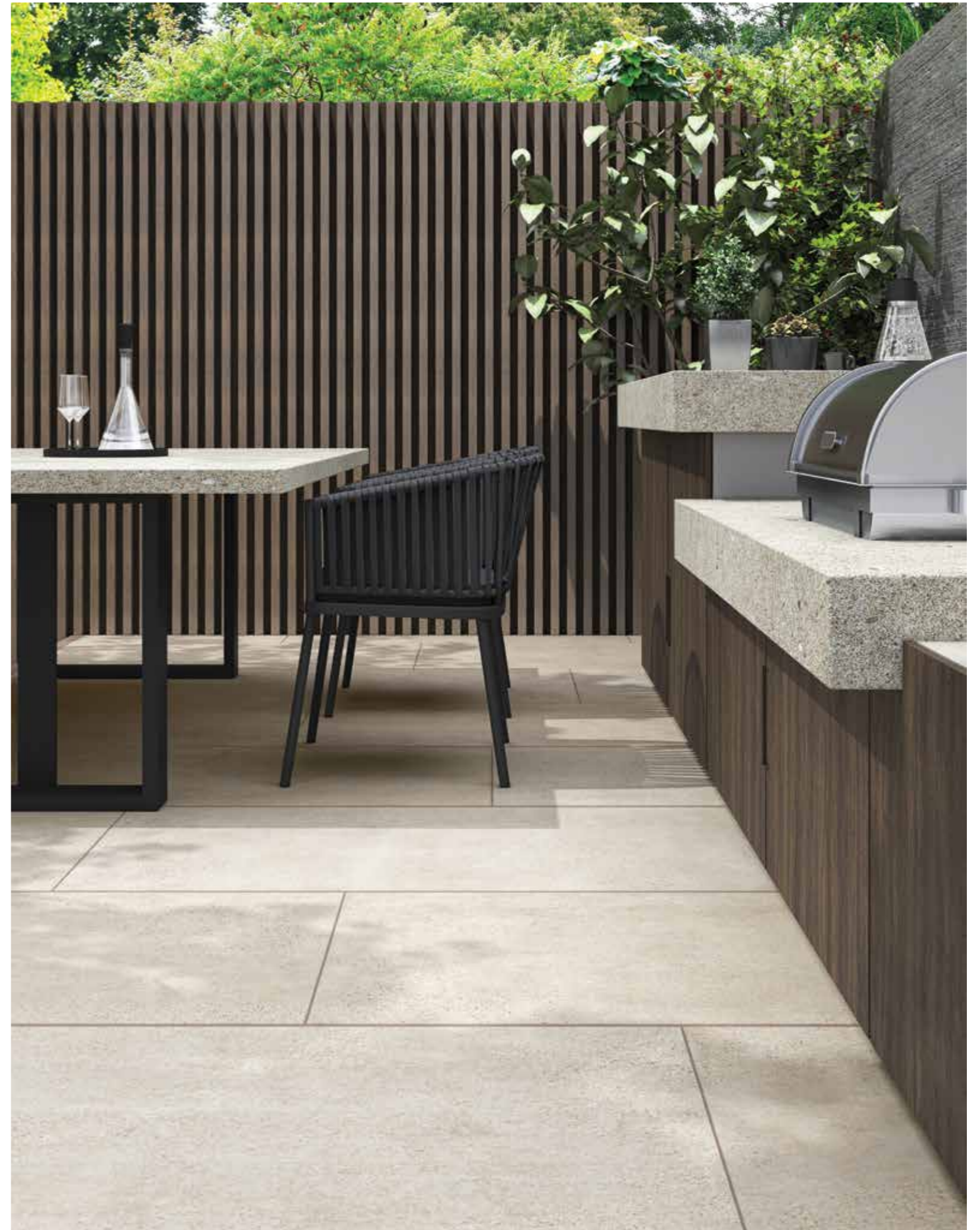
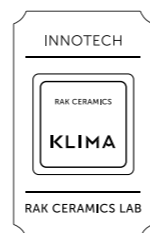
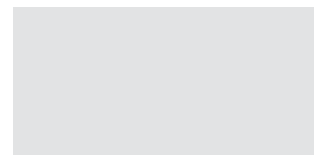



## HIGH PERFORMANCE TECHNICAL PRODUCTS BAREFOOT + ANTISLIP (A+B+C)

The Antislip Barefoot + technology gives porcelain tiles excellent non-slip performance and pleasant feel, with a special roughness imperceptible to the touch. All products equipped with the Antislip Barefoot + technology become anti-slip in wet conditions, that makes these tiles a must have for indoor areas subject to moisture and outdoor applications.

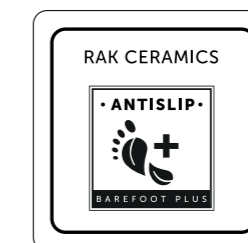

# Breccia Adige Stone

FULL BODY PORCELAIN TILES  
Matt • Rectified • Light Structure



breccia adige stone white



breccia adige stone beige



breccia adige stone taupe



breccia adige stone brown

**Mosaic**



breccia adige stone mosaic 30x30 \*



breccia adige stone mosaic 30x40 \*



breccia adige stone mosaic 30x45 \*



breccia adige stone mosaic 30x60 \*



step & riser \*

**SIZES**

80x80 cm  
31.49"x31.49"

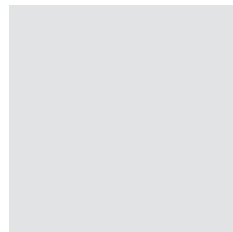

60x120 cm  
23.62"x47.24"

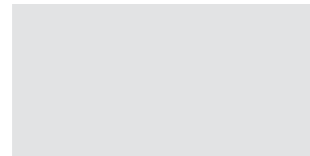

60x60 cm  
23.62"x23.62"

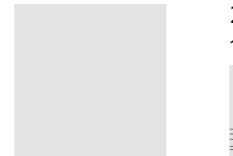

Step  
29.8x60 cm  
11.73"x23.62"



Step  
30x120 cm  
11.81"x47.24"



\* Available in all colours



mosaic  
30x30 cm  
11.81"x11.81"



mosaic  
30x40 cm  
11.81"x15.74"



mosaic  
30x45 cm  
11.81"x17.71"



mosaic  
30x60 cm  
11.81"x23.62"



skirting  
60x8 cm  
23.62"x3.14"

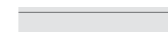

Riser  
15x120 cm  
5.90"x47.24"



| Name                      | Code               | Size(CM) | Code               | Size(CM) | Code               | Size(CM) | Code               | Size(CM) |
|---------------------------|--------------------|----------|--------------------|----------|--------------------|----------|--------------------|----------|
| breccia adige stone beige | A12GBDGS-BEE.A6X5R | 60x120   | A05GBDGS-BEE.A6X0R | 80x80    | A06GBDGS-BEE.A6X0R | 60x60    | A05GBDGS-BEE.A6X0R | 30x60    |
| breccia adige stone brown | A12GBDGS-BRN.A6X5R | 60x120   | A05GBDGS-BRN.A6X0R | 80x80    | A06GBDGS-BRN.A6X0R | 60x60    | A05GBDGS-BRN.A6X0R | 30x60    |
| breccia adige stone taupe | A12GBDGS-TPE.A6X5R | 60x120   | A05GBDGS-TPE.A6X0R | 80x80    | A06GBDGS-TPE.A6X0R | 60x60    | A05GBDGS-TPE.A6X0R | 30x60    |
| breccia adige stone white | A12GBDGS-WHE.A6X5R | 60x120   | A05GBDGS-WHE.A6X0R | 80x80    | A06GBDGS-WHE.A6X0R | 60x60    | A05GBDGS-WHE.A6X0R | 30x60    |

| Name                                       | Code               | Size(CM) | Name                                       | Code               | Size(CM) |
|--|--------------------|----------|--|--------------------|----------|
| breccia adige beige mosaic 30x30 (2.5x2.5) | A2MZZBDGSBEE047482 | 30x30    | breccia adige brown mosaic 30x30 (2.5x2.5) | A2MZZBDGSBRN047483 | 30x30    |
| breccia adige beige mosaic 30x30 (4.7x4.7) | A2MZZBDGSBEE047486 | 30x30    | breccia adige brown mosaic 30x30 (4.7x4.7) | A2MZZBDGSBRN047487 | 30x30    |
| breccia adige beige mosaic 30x30           | A2MZZBDGSBEE047124 | 30x30    | breccia adige brown mosaic 30x30           | A2MZZBDGSBRN047125 | 30x30    |
| breccia adige beige mosaic 30x40           | A2MZZBDGSBEE047128 | 30x40    | breccia adige brown mosaic 30x40           | A2MZZBDGSBRN047129 | 30x40    |
| breccia adige beige mosaic 30x45           | A2MZZBDGSBEE047290 | 30x45    | breccia adige brown mosaic 30x45           | A2MZZBDGSBRN047291 | 30x45    |
| breccia adige beige mosaic 30x60           | A2MZZBDGSBEE047294 | 30x60    | breccia adige brown mosaic 30x60           | A2MZZBDGSBRN047295 | 30x60    |
| breccia adige beige skirting               | A2SZZBDGSBEE049921 | 9.6x120  | breccia adige brown skirting               | A2SZZBDGSBRN049922 | 9.6x120  |
| breccia adige beige skirting               | A2SZZBDGSBEE049917 | 9.6x80   | breccia adige brown skirting               | A2SZZBDGSBRN049918 | 9.6x80   |
| breccia adige beige skirting               | A2SZZBDGSBEE050253 | 8x60     | breccia adige brown skirting               | A2SZZBDGSBRN050254 | 8x60     |
| breccia adige beige step                   | AGTZZBDGSBEE049181 | 29.8x60  | breccia adige brown step                   | AGTZZBDGSBRN049182 | 29.8x60  |
| breccia adige beige step                   | AGTZZBDGSBEE046622 | 30x120   | breccia adige brown step                   | AGTZZBDGSBRN046623 | 30x120   |
| breccia adige beige riser                  | AGRZZBDGSBEE046626 | 15x120   | breccia adige brown riser                  | AGRZZBDGSBRN046627 | 15x120   |

|  |                    |         |  |                    |         |
|--|--------------------|---------|--|--------------------|---------|
| breccia adige taupe mosaic 30x30 (2.5x2.5) | A2MZZBDGSTPE047484 | 30x30   | breccia adige white mosaic 30x30 (2.5x2.5) | A2MZZBDGSWHE047485 | 30x30   |
| breccia adige taupe mosaic 30x30 (4.7x4.7) | A2MZZBDGSTPE047488 | 30x30   | breccia adige white mosaic 30x30 (4.7x4.7) | A2MZZBDGSWHE047489 | 30x30   |
| breccia adige taupe mosaic 30x30           | A2MZZBDGSTPE047126 | 30x30   | breccia adige white mosaic 30x30           | A2MZZBDGSWHE047127 | 30x30   |
| breccia adige taupe mosaic 30x40           | A2MZZBDGSTPE047130 | 30x40   | breccia adige white mosaic 30x40           | A2MZZBDGSWHE047131 | 30x40   |
| breccia adige taupe mosaic 30x45           | A2MZZBDGSTPE047292 | 30x45   | breccia adige white mosaic 30x45           | A2MZZBDGSWHE047293 | 30x45   |
| breccia adige taupe mosaic 30x60           | A2MZZBDGSTPE047296 | 30x60   | breccia adige white mosaic 30x60           | A2MZZBDGSWHE047297 | 30x60   |
| breccia adige taupe skirting               | A2SZZBDGSTPE049923 | 9.6x120 | breccia adige white skirting               | A2SZZBDGSWHE049924 | 9.6x120 |
| breccia adige taupe skirting               | A2SZZBDGSTPE049919 | 9.6x80  | breccia adige white skirting               | A2SZZBDGSWHE049920 | 9.6x80  |
| breccia adige taupe skirting               | A2SZZBDGSTPE050255 | 8x60    | breccia adige white skirting               | A2SZZBDGSWHE050256 | 8x60    |
| breccia adige taupe step                   | AGTZZBDGSTPE049183 | 29.8x60 | breccia adige white step                   | AGTZZBDGSWHE049184 | 29.8x60 |
| breccia adige taupe step                   | AGTZZBDGSTPE046624 | 30x120  | breccia adige white step                   | AGTZZBDGSWHE046625 | 30x120  |
| breccia adige taupe riser                  | AGRZZBDGSTPE046628 | 15x120  | breccia adige white riser                  | AGRZZBDGSWHE046629 | 15x120  |

# Burano

FULL BODY PORCELAIN TILES  
Matt • Rectified • Smooth



burano white



burano grey

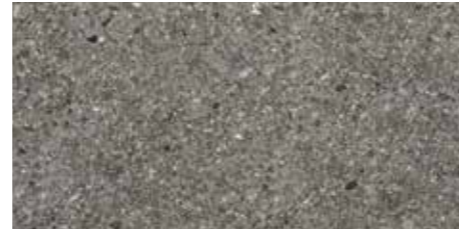

burano dark grey

## Mosaic

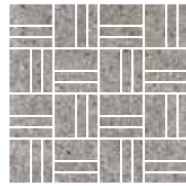

burano mosaic 30x30 \*

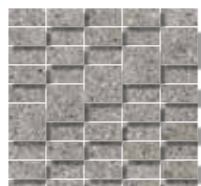

burano 3D mosaic 28.8x28.8 \*

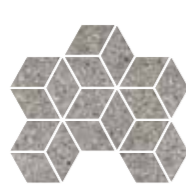

burano mosaic 25.5x29.5 \*

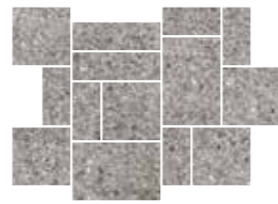

burano mosaic 30x40 \*



burano mosaic 30x45 \*

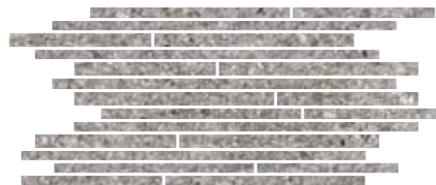

burano mosaic 30x60 \*



step & riser \*



## SIZES



\* Available in all colours

60x120 cm  
23.62"x47.24"

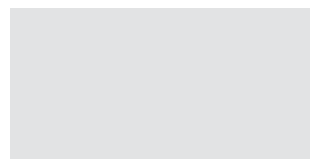

60x60 cm  
23.62"x23.62"

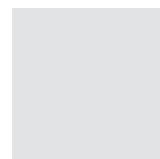

Step  
29.8x60 cm  
11.73"x23.62"

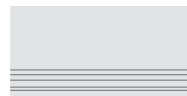

Step  
30x120 cm  
11.81"x47.24"



Riser  
15x120 cm  
5.90"x47.24"

skirting  
60x8 cm  
23.62"x3.14"

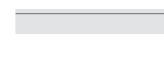

mosaic  
30x30 cm  
11.81"x11.81"



mosaic 3d  
28.8x28.8 cm  
11.33"x11.33"



mosaic  
25.5x29.5 cm  
10.03"x11.61"



mosaic  
30x40 cm  
11.81"x15.74"



mosaic  
30x45 cm  
11.81"x17.71"



mosaic  
30x60 cm  
11.81"x23.62"



| Name             | Code               | Size(CM) | Code               | Size(CM) |
|------------------|--------------------|----------|--------------------|----------|
| burano white     | A12GBRUO-WHE.MoX5R | 60x120   | Ao6GBRUO-WHE.MoXoR | 60x60    |
| burano grey      | A12GBRUO-GRY.MoX5R | 60x120   | Ao6GBRUO-GRY.MoXoR | 60x60    |
| burano dark grey | A12GBRUO-DKG.MoX5R | 60x120   | Ao6GBRUO-DKG.MoXoR | 60x60    |

| Name                          | Code               | Size(CM) | Name                            | Code               | Size(CM) |
|-------------------------------|--------------------|----------|---------------------------------|--------------------|----------|
| burano white mosaic 30x30     | AGMZZBRUOWHE029257 | 30x30    | burano white mosaic 2.5x2.5     | AGMZZBRUOWHE029239 | 30x30    |
| burano grey mosaic 30x30      | AGMZZBRUOGRY029251 | 30x30    | burano grey mosaic 2.5x2.5      | AGMZZBRUOGRY029237 | 30x30    |
| burano dark grey mosaic 30x30 | AGMZZBRUODKG029245 | 30x30    | burano dark grey mosaic 2.5x2.5 | AGMZZBRUODKG029235 | 30x30    |

|                                 |                    |       |                               |                    |       |
|---------------------------------|--------------------|-------|-------------------------------|--------------------|-------|
| burano white mosaic 4.7x4.7     | AGMZZBRUOWHE029214 | 30x30 | burano white mosaic 30x40     | AGMZZBRUOWHE031028 | 30x40 |
| burano grey mosaic 4.7x4.7      | AGMZZBRUOGRY029212 | 30x30 | burano grey mosaic 30x40      | AGMZZBRUOGRY031026 | 30x40 |
| burano dark grey mosaic 4.7x4.7 | AGMZZBRUODKG029210 | 30x30 | burano dark grey mosaic 30x40 | AGMZZBRUODKG031024 | 30x40 |

|                           |                    |       |                               |                    |       |
|---------------------------|--------------------|-------|-------------------------------|--------------------|-------|
| burano white mosaic 30x45 | AGMZZBRUOWHE029286 | 30x45 | burano white mosaic 30x60     | AGMZZBRUOWHE029310 | 30x60 |
| burano grey mosaic 30x45  | AGMZZBRUOGRY029284 | 30x45 | burano grey mosaic 30x60      | AGMZZBRUOGRY029308 | 30x60 |
| desert mosaic 30x45       | AGMZZBRUODKG029282 | 30x45 | burano dark grey mosaic 30x60 | AGMZZBRUODKG029306 | 30x60 |

|                       |                    |        |                        |                    |        |
|-----------------------|--------------------|--------|------------------------|--------------------|--------|
| burano white step     | AGTZZBRUOWHE029125 | 30x120 | burano white riser     | AGRZZBRUOWHE029108 | 15x120 |
| burano grey step      | AGTZZBRUOGRY029123 | 30x120 | burano grey riser      | AGRZZBRUOGRY029106 | 15x120 |
| burano dark grey step | AGTZZBRUODKG029121 | 30x120 | burano dark grey riser | AGRZZBRUODKG029104 | 15x120 |

# Lava Concrete

FULL BODY PORCELAIN TILES  
Matt • Rectified • Light Structure



lava concrete white



lava concrete beige



lava concrete light grey

Mosaic



lava concrete mosaic 30x30 \*



lava concrete 3D mosaic 28.8x28.8 \*



lava concrete mosaic 25.5x29.5 \*



lava concrete mosaic 30x40 \*



lava concrete mosaic 30x45 \*



lava concrete mosaic 30x60 \*



step & riser \*

SIZES



\* Available in all colours

60x120 cm  
23.62"x47.24"

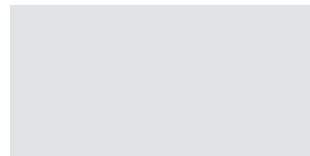

60x60 cm  
23.62"x23.62"

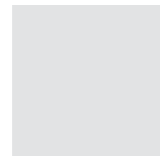

Step  
29.8x60 cm  
11.73"x23.62"

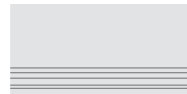

Step  
30x120 cm  
11.81"x47.24"



Riser  
15x120 cm  
5.90"x47.24"

skirting  
60x8 cm  
23.62"x3.14"



mosaic  
30x30 cm  
11.81"x11.81"



mosaic 3d  
28.8x28.8 cm  
11.33"x11.33"



mosaic  
25.5x29.5 cm  
10.03"x11.61"



mosaic  
30x40 cm  
11.81"x15.74"



mosaic  
30x45 cm  
11.81"x17.71"



mosaic  
30x60 cm  
11.81"x23.62"



| Name                                      | Code               | Size(CM)  | Code   | Size(CM)           |           |
|---|--------------------|-----------|--|--------------------|-----------|
| lava concrete white                       | A2B12LVCRWHEMML5R  | 60x120    | A2B06LVCRWHEMMLNLR                           | 60x60              |           |
| lava concrete light grey                  | A2B12LVCRLIGMML5R  | 60x120    | A2B06LVCRLIGMMLNLR                           | 60x60              |           |
| lava concrete beige                       | A2B12LVCRBEEML5R   | 60x120    | A2B06LVCRBEEMLNLR                            | 60x60              |           |
| Name                                      | Code               | Size(CM)  | Name   | Code               | Size(CM)  |
| lava concrete white mosaic 30x30          | ACMZZLVCRWHE005563 | 30x30     | lava concrete white mosaic 30x40             | ACMZZLVCRWHE005536 | 30x40     |
| lava concrete light grey mosaic 30x30     | ACMZZLVCRLIG005562 | 30x30     | lava concrete light grey mosaic 30x40        | ACMZZLVCRLIG005535 | 30x40     |
| lava concrete beige mosaic 30x30          | ACMZZLVCRBEE005561 | 30x30     | lava concrete beige mosaic 30x40             | ACMZZLVCRBEE005534 | 30x40     |
| lava concrete white mosaic 25.5x29.5      | AGWZZLVCRWHE005505 | 25.5x29.5 | lava concrete white mosaic 30x45             | ACMZZLVCRWHE005568 | 30x45     |
| lava concrete light grey mosaic 25.5x29.5 | AGWZZLVCRLIG005504 | 25.5x29.5 | lava concrete light grey mosaic 30x45        | ACMZZLVCRLIG005567 | 30x45     |
| lava concrete beige mosaic 25.5x29.5      | AGWZZLVCRBEE005503 | 25.5x29.5 | lava concrete beige mosaic 30x45             | ACMZZLVCRBEE005566 | 30x45     |
| lava concrete white mosaic 30x60          | ACMZZLVCRWHE005573 | 30x60     | lava concrete white 3D mosaic 28.8x28.8      | ACMZZLVCRWHE005859 | 28.8x28.8 |
| lava concrete light grey mosaic 30x60     | ACMZZLVCRLIG005572 | 30x60     | lava concrete light grey 3D mosaic 28.8x28.8 | ACMZZLVCRLIG005857 | 28.8x28.8 |
| lava concrete beige mosaic 30x60          | ACMZZLVCRBEE005571 | 30x60     | lava concrete beige 3D mosaic 28.8x28.8      | ACMZZLVCRBEE005858 | 28.8x28.8 |
| lava concrete white step                  | ACTZZLVCRWHE006628 | 29.8x60   | lava concrete white skirting                 | ACSZZLVCRWHE005522 | 60x8      |
| lava concrete light grey step             | ACTZZLVCRLIG006626 | 29.8x60   | lava concrete light grey skirting            | ACSZZLVCRLIG005518 | 60x8      |
| lava concrete beige step                  | ACTZZLVCRBEE006624 | 29.8x60   | lava concrete beige skirting                 | ACSZZLVCRBEE005521 | 60x8      |
| lava concrete white step                  | ACTZZLVCRWHE005958 | 30x120    | lava concrete white riser                    | ACRZZLVCRWHE005963 | 15x120    |
| lava concrete light grey step             | ACTZZLVCRLIG005955 | 30x120    | lava concrete light grey riser               | ACRZZLVCRLIG005961 | 15x120    |
| lava concrete beige step                  | ACTZZLVCRBEE005953 | 30x120    | lava concrete beige riser                    | ACRZZLVCRBEE005959 | 15x120    |

# Lapideus

FULL BODY PORCELAIN TILES  
Matt • Rectified • Light Structure



lapideus white



lapideus slate grey



lapideus original



lapideus beige

**Mosaic**

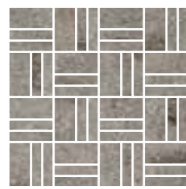

lapideus mosaic 30x30 \*



lapideus mosaic 30x40 \*



lapideus mosaic 30x45 \*



lapideus slate grey mosaic 30x60 \*



step & riser \*

**SIZES**

60x120 cm  
23.62"x47.24"

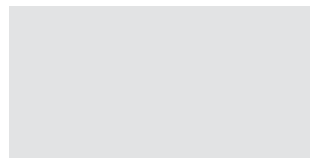

60x60 cm  
23.62"x23.62"

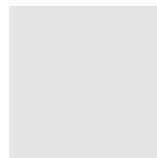

Step  
29.8x60 cm  
11.73"x23.62"



Step  
30x120 cm  
11.81"x47.24"

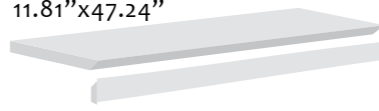

Riser  
15x120 cm  
5.90"x47.24"

skirting  
60x8 cm  
23.62"x3.14"

\* Available in all colours

mosaic  
30x30 cm  
11.81"x11.81"



mosaic  
30x40 cm  
11.81"x15.74"



mosaic  
30x45 cm  
11.81"x17.71"



mosaic  
30x60 cm  
11.81"x23.62"

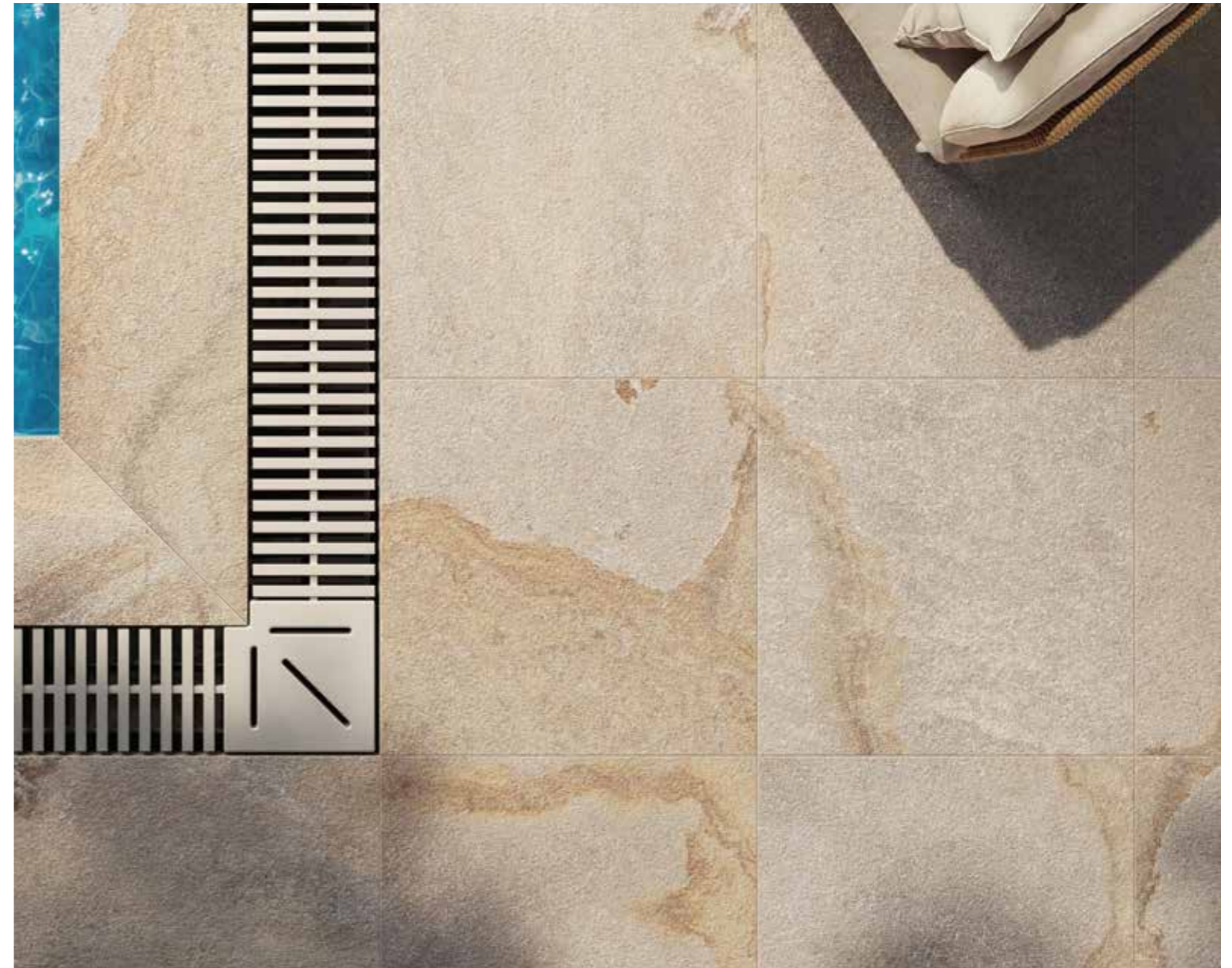

| Name                             | Code               | Size(CM) | Code                             | Size(CM)           |          |
|----------------------------------|--------------------|----------|----------------------------------|--------------------|----------|
| lapideus white                   | A12GLPSE-WHE.M6X5R | 60x120   | A06GLPSE-WHE.M6X0R               | 60x60              |          |
| lapideus slate grey              | A12GLPSE-SLA.M6X5R | 60x120   | A06GLPSE-SLA.M6X0R               | 60x60              |          |
| lapideus beige                   | A12GLPSE-BEE.M6X5R | 60x120   | A06GLPSE-BEE.M6X0R               | 60x60              |          |
| lapideus original                | A12GLPSE-OGL.M6X5R | 60x120   | A06GLPSE-OGL.M6X0R               | 60x60              |          |
| Name                             | Code               | Size(CM) | Name                             | Code               | Size(CM) |
| lapideus white mosaic 30x30      | A2MZZLPSEWHE007697 | 30x30    | lapideus white mosaic 30x40      | A2MZZLPSEWHE007789 | 30x40    |
| lapideus slate grey mosaic 30x30 | A2MZZLPSESLA007696 | 30x30    | lapideus slate grey mosaic 30x40 | A2MZZLPSESLA007788 | 30x40    |
| lapideus beige mosaic 30x30      | A2MZZLPSEBEE007693 | 30x30    | lapideus beige mosaic 30x40      | A2MZZLPSEBEE007784 | 30x40    |
| lapideus original mosaic 30x30   | A2MZZLPSEOGL007695 | 30x30    | lapideus original mosaic 30x40   | A2MZZLPSEOGL007786 | 30x40    |
| lapideus white mosaic 30x45      | A2MZZLPSEWHE007666 | 30x45    | lapideus white mosaic 30x60      | A2MZZLPSEWHE007731 | 30x60    |
| lapideus slate grey mosaic 30x45 | A2MZZLPSESLA007665 | 30x45    | lapideus slate grey mosaic 30x60 | A2MZZLPSESLA007730 | 30x60    |
| lapideus beige mosaic 30x45      | A2MZZLPSEBEE007661 | 30x45    | lapideus beige mosaic 30x60      | A2MZZLPSEBEE007726 | 30x60    |
| lapideus original mosaic 30x45   | A2MZZLPSEOGL007663 | 30x45    | lapideus original mosaic 30x60   | A2MZZLPSEOGL007728 | 30x60    |
| lapideus white step              | A2TZLPSEWHE017617  | 30x60    | lapideus white skirting          | AGSZLPSEWHE007713  | 60x8     |
| lapideus slate grey step         | A2TZLPSESLA017616  | 30x60    | lapideus slate grey skirting     | AGSZLPSESLA007712  | 60x8     |
| lapideus original step           | A2TZLPSEOGL017614  | 30x60    | lapideus beige skirting          | AGSZLPSEBEE007708  | 60x8     |
| lapideus pece step               | A2TZLPSEPEC017615  | 30x60    | lapideus original skirting       | AGSZLPSEOGL007710  | 60x8     |
| lapideus white riser             | A2RZZLPSEWHE008308 | 15x120   | lapideus white riser             | A2RZZLPSEWHE008308 | 15x120   |
| lapideus slate grey riser        | A2RZZLPSESLA008307 | 15x120   | lapideus slate grey riser        | A2RZZLPSESLA008307 | 15x120   |
| lapideus beige riser             | A2RZZLPSEBEE008303 | 15x120   | lapideus beige riser             | A2RZZLPSEBEE008303 | 15x120   |
| lapideus original riser          | A2RZZLPSEOGL008305 | 15x120   | lapideus original riser          | A2RZZLPSEOGL008305 | 15x120   |



PRODUCTS WITH R11 AND STANDARD THICKNESS

PRODUCTS WITH R11 AND STANDARD THICKNESS

# Curton

FULL BODY PORCELAIN TILES  
Matt • Rectified • Heavy Structure



curton white decor



curton grey decor



curton beige decor

SIZES

60x120 cm  
23.62"x47.24"

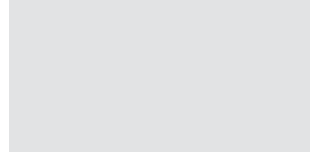

60x60 cm  
23.62"x23.62"

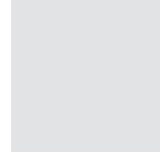

Step  
29.8x60 cm  
11.73"x23.62"

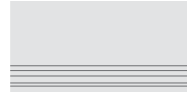

mosaic  
30x30 cm  
11.81"x11.81"



mosaic 3d  
28.8x28.8 cm  
11.33"x11.33"



mosaic  
25.5x29.5 cm  
10.03"x11.61"



mosaic  
30x40 cm  
11.81"x15.74"



mosaic  
30x45 cm  
11.81"x17.71"



mosaic  
30x60 cm  
11.81"x23.62"



| Name               | Code             | Size(CM) | Code              | Size(CM) |
|--------------------|------------------|----------|-------------------|----------|
| curton white decor | A2D12PDCNWHMML5R | 60x120   | A2D06PDCNWHMMLN1R | 60x60    |
| curton grey decor  | A2D12PDCNGRYML5R | 60x120   | A2D06PDCNGRYMLN1R | 60x60    |
| curton beige decor | A2D12PDCNBEEML5R | 60x120   | A2D06PDCNBEEMLN1R | 60x60    |

  

| Name                      | Code               | Size(CM)  | Name                      | Code               | Size(CM)  |
|---------------------------|--------------------|-----------|---------------------------|--------------------|-----------|
| curton white mosaic 30x30 | ACMZZPDCNWH006687  | 30x30     | curton white mosaic 30x40 | ACMZZPDCNWH006688  | 30x40     |
| curton grey mosaic 30x30  | ACMZZPDCNGRY005661 | 30x30     | curton grey mosaic 30x40  | ACMZZPDCNGRY005658 | 30x40     |
| curton beige mosaic 30x30 | ACMZZPDCNBEE005660 | 30x30     | curton beige mosaic 30x40 | ACMZZPDCNBEE005657 | 30x40     |
| curton white mosaic 30x60 | ACMZZPDCNWH006689  | 30x60     | curton white mosaic 30x45 | ACMZZPDCNWH006690  | 30x45     |
| curton grey mosaic 30x60  | ACMZZPDCNGRY005733 | 30x60     | curton grey mosaic 30x45  | ACMZZPDCNGRY005730 | 30x45     |
| curton beige mosaic 30x60 | ACMZZPDCNBEE005732 | 30x60     | curton beige mosaic 30x45 | ACMZZPDCNBEE005729 | 30x45     |
| curton white mosaic 30x60 | AGWZZPDCNBEE005479 | 25.5x29.5 | curton white              | ACMZZPDCNBEE005860 | 28.8x28.8 |
| curton grey mosaic 30x60  | AGWZZPDCNGRY005480 | 25.5x29.5 | curton grey               | ACMZZPDCNGRY005871 | 28.8x28.8 |
| curton beige mosaic 30x60 | A2VZZPDCNWH006730  | 25.5x29.5 | curton beige              | ACMZZPDCNWH006686  | 28.8x28.8 |



# Shine Stone

PORCELAIN TILES  
Matt • Rectified • Light Structure

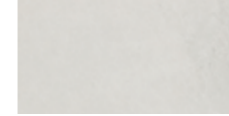

shine stone white



shine stone grey



shine stone dark grey



shine stone black

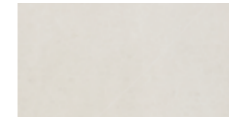

shine stone ivory

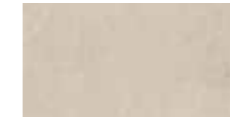

shine stone beige



shine stone dark beige



shine stone brown

Mosaic

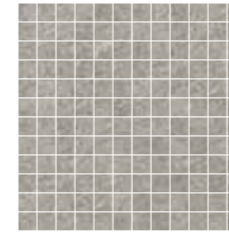

shine stone mosaic 2.3x2.3 \*

SIZES

30x60 cm  
11.81"x23.62"

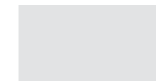

mosaic  
30x30 cm  
11.81"x11.81"



\* Available in all colours

| Name                   | Code             | Size(CM) | Name                                  | Code               | Size(CM) |
|------------------------|------------------|----------|---------------------------------------|--------------------|----------|
| shine stone white      | A09GZSHS#WHO.MYR | 30x60    | shine stone white mosaic 2.3x2.3      | AM-GZSHS-WH.2R/2H  | 30x30    |
| shine stone grey       | A09GZSHS#GYO.MYR | 30x60    | shine stone grey mosaic 2.3x2.3       | AM-GZSHS-GY.2R/2H  | 30x30    |
| shine stone dark grey  | A09GZSHS#DGY.MYR | 30x60    | shine stone dark grey mosaic 2.3x2.3  | AM-GZSHS-DGY.2R/2H | 30x30    |
| shine stone black      | A09GZSHS#BKO.MYR | 30x60    | shine stone black mosaic 2.3x2.3      | AM-GZSHS-BK.2R/2H  | 30x30    |
| shine stone ivory      | A09GZSHS#VO.MYR  | 30x60    | shine stone ivory mosaic 2.3x2.3      | AM-GZSHS-IV.2R/2H  | 30x30    |
| shine stone beige      | A09GZSHS#BEO.MYR | 30x60    | shine stone beige mosaic 2.3x2.3      | AM-GZSHS-BE.2R/2H  | 30x30    |
| shine stone dark beige | A09GZSHS#DBE.MYR | 30x60    | shine stone dark beige mosaic 2.3x2.3 | AM-GZSHS-DBE.2R/2H | 30x30    |
| shine stone brown      | A09GZSHS#BRO.MYR | 30x60    | shine stone brown mosaic 2.3x2.3      | AM-GZSHS-BR.2R/2H  | 30x30    |



A modern outdoor swimming pool area. In the foreground, a pool ladder with three stainless steel handrails leads into the water. The pool deck is made of light-colored stone tiles. To the left, a wooden lounge chair with light-colored cushions and a rolled-up towel sits on the deck. In the background, a large glass-walled building reflects the surrounding greenery and sky. The scene is set in a lush, tropical environment with large trees and plants.

## Swimming pool accessories

From  
**Atecpool**  
(Not supplied by RAK Ceramics)



# Swimming pool ladders

## Standard Ladder

Ladders for residential and commercial swimming pools, made of polished stainless steel AISI 316 or AISI 304. Steps in Stainless Steel with anti-slip security. Complete with anchors and earthing accessories.

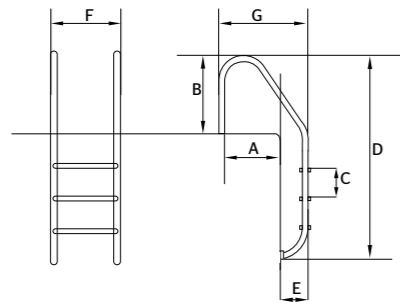

| Steps | A    | B    | C    | D    | E    | F    | G    |
|-------|------|------|------|------|------|------|------|
|       | (mm) | (mm) | (mm) | (mm) | (mm) | (mm) | (mm) |
| 2     | 410  | 620  | 250  | 1300 | 180  | 500  | 610  |
| 3     | 410  | 620  | 250  | 1550 | 180  | 500  | 610  |
| 4     | 410  | 620  | 250  | 1800 | 180  | 500  | 610  |
| 5     | 410  | 620  | 250  | 2050 | 180  | 500  | 610  |

### Deluxe S.S. 316



| Code             | Weight     | Volume         |      |
|------------------|------------|----------------|------|
| AISI 316         | (kg)       | m <sup>3</sup> |      |
| 2 steps standard | 13003215-5 | 10.0           | 0.07 |
| 3 steps standard | 13003215-6 | 11.8           | 0.08 |
| 4 steps standard | 13003215-7 | 13.2           | 0.08 |
| 5 steps standard | 13003215-8 | 14.0           | 0.10 |

### Deluxe S.S. 304



| Code             | Weight     | Volume         |      |
|------------------|------------|----------------|------|
| AISI 304         | (kg)       | m <sup>3</sup> |      |
| 2 steps standard | 13003215-1 | 10.0           | 0.07 |
| 3 steps standard | 13003215-2 | 11.8           | 0.08 |
| 4 steps standard | 13003215-3 | 13.2           | 0.08 |
| 5 steps standard | 13003215-4 | 14.0           | 0.10 |

## Overflow Ladder

Over low Ladder with 957mm extended fixing. Made of polished stainless steel AISI 304 or AISI 316. Handrails in polished Stainless steel (Ø42mm) tube. Steps in Stainless steel with anti-slip security. Complete with anchors and earthing accessories.

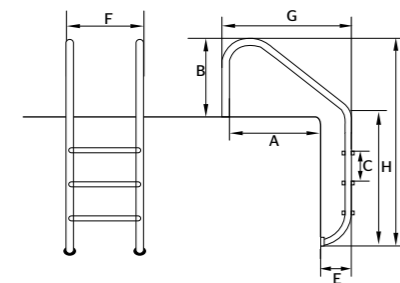

| Steps | A    | B    | C    | D    | E    | F    | G    | H    |
|-------|------|------|------|------|------|------|------|------|
|       | (mm) | (mm) | (mm) | (mm) | (mm) | (mm) | (mm) | (mm) |
| 2     | 757  | 610  | 250  | 1390 | 180  | 500  | 957  | 710  |
| 3     | 757  | 610  | 250  | 1640 | 180  | 500  | 957  | 960  |
| 4     | 757  | 610  | 250  | 1890 | 180  | 500  | 957  | 1210 |
| 5     | 757  | 610  | 250  | 2140 | 180  | 500  | 957  | 1460 |

### Deluxe S.S. 316



| Code             | Weight      | Volume         |      |
|------------------|-------------|----------------|------|
| AISI 316         | (kg)        | m <sup>3</sup> |      |
| 2 steps overflow | 13003215-13 | 10.0           | 0.07 |
| 3 steps overflow | 13003215-14 | 12.0           | 0.08 |
| 4 steps overflow | 13003215-15 | 14.0           | 0.08 |
| 5 steps overflow | 13003215-16 | 15.0           | 0.10 |

### Deluxe S.S. 304



| Code             | Weight      | Volume         |      |
|------------------|-------------|----------------|------|
| AISI 304         | (kg)        | m <sup>3</sup> |      |
| 2 steps overflow | 13003215-9  | 10.0           | 0.07 |
| 3 steps overflow | 13003215-10 | 12.0           | 0.08 |
| 4 steps overflow | 13003215-11 | 14.0           | 0.08 |
| 5 steps overflow | 13003215-12 | 15.0           | 0.10 |

## Standard Asymmetrical Ladder

Atecpool standard asymmetrical ladders made of AISI 316 are designed for safety against slipping from any asymmetrical pool surface or slopes. Steps in Stainless steel with anti-slip security. Complete with anchors and earthing accessories.

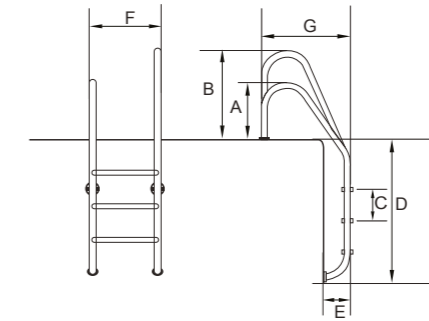

| Steps | A    | B    | C    | D    | E    | F    | G    |
|-------|------|------|------|------|------|------|------|
|       | (mm) | (mm) | (mm) | (mm) | (mm) | (mm) | (mm) |
| 2     | 620  | 920  | 250  | 1300 | 180  | 500  | 738  |
| 3     | 620  | 920  | 250  | 1550 | 180  | 500  | 738  |
| 4     | 620  | 920  | 250  | 1800 | 180  | 500  | 738  |
| 5     | 620  | 920  | 250  | 2050 | 180  | 500  | 738  |

### Deluxe S.S. 316



| Code                 | Weight     | Volume         |      |
|----------------------|------------|----------------|------|
| AISI 316             | (kg)       | m <sup>3</sup> |      |
| 2 steps asymmetrical | 13002200-1 | 10.0           | 0.07 |
| 3 steps asymmetrical | 13002300-1 | 11.8           | 0.08 |
| 4 steps asymmetrical | 13002400-1 | 13.2           | 0.08 |
| 5 steps asymmetrical | 13002500-1 | 14.0           | 0.10 |



# Swimming pool showers

## Waterfall Collection

Waterfall collection is an elegant addition to your new or remodel pool or spa. With our Waterfall Collection you could add a peaceful atmosphere to your pool or a bold looking water feature that brings thrill & uniqueness to your project.

## Classic Waterfall

### Specifications

- Construction in Heavy-duty PVC.
- Selected Lip sizes can be radius curve cut.
- Available in Clear, Gray & Tan color options on request.
- Both Rear & Bottom inlet options available.
- Various size options, up to 5 ft. length

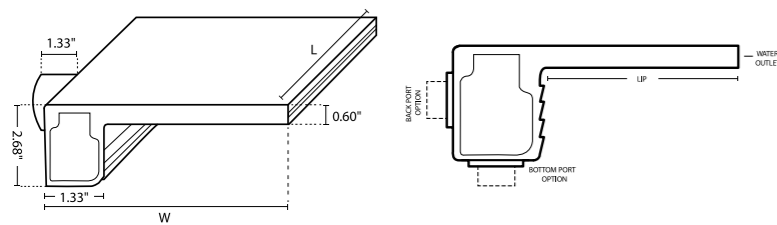

| Colour     | Description  | Result at 1 Meter Height   | Width | Length |
|------------|--------------|----------------------------|-------|--------|
| Rear Inlet | Bottom Inlet | GPM / Projection           | (W)   | (L)    |
| 4600-1201  | 4601-1201    | 12 waterfall with 1" lip   | 3.15  |        |
| 4600-1206  | 4601-1206    | 12" waterfall with 6" lip  | 8.07  | 12.36  |
| 4600-1209  | 4601-1209    | 12" waterfall with 9" lip  | 11.07 |        |
| 4600-1212  | 4601-1212    | 12" waterfall with 12" lip | 14.07 |        |
| 4600-1801  | 4601-1801    | 18" waterfall with 1" lip  | 3.15  |        |
| 4600-1806  | 4601-1806    | 18" waterfall with 6" lip  | 8.07  | 18.23  |
| 4600-1809  | 4601-1809    | 18" waterfall with 9" lip  | 11.07 |        |
| 4600-1812  | 4601-1812    | 18" waterfall with 12" lip | 14.07 |        |
| 4600-2401  | 4601-2401    | 24" waterfall with 1" lip  | 3.15  |        |
| 4600-2406  | 4601-2406    | 24" waterfall with 6" lip  | 8.07  | 24.13  |
| 4600-2409  | 4601-2409    | 24" waterfall with 9" lip  | 11.07 |        |
| 4600-2412  | 4601-2412    | 24" waterfall with 12" lip | 14.07 |        |
| 4600-3601  | 4601-3601    | 36" waterfall with 1" lip  | 3.15  |        |
| 4600-3606  | 4601-3606    | 36" waterfall with 6" lip  | 8.07  | 35.67  |
| 4600-3609  | 4601-3609    | 36" waterfall with 9" lip  | 11.07 |        |
| 4600-3612  | 4601-3612    | 36" waterfall with 12" lip | 14.07 |        |
| 4600-4801  | 4601-4801    | 48" waterfall with 1" lip  | 3.15  |        |
| 4600-4806  | 4601-4806    | 48" waterfall with 6" lip  | 8.07  | 47.36  |
| 4600-4809  | 4601-4809    | 48" waterfall with 9" lip  | 11.07 |        |
| 4600-4812  | 4601-4812    | 48" waterfall with 12" lip | 14.07 |        |
| 4600-6001  | -            | 60" waterfall with 1" lip  | 3.15  |        |
| 4600-6006  | -            | 60" waterfall with 6" lip  | 8.07  | 59.88  |
| 4600-6009  | -            | 60" waterfall with 9" lip  | 11.07 |        |
| 4600-6012  | -            | 60" waterfall with 12" lip | 14.07 |        |

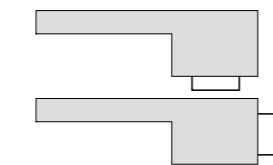

Back or Bottom Port

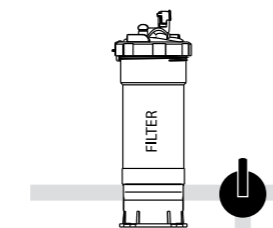

Filtered Water Only

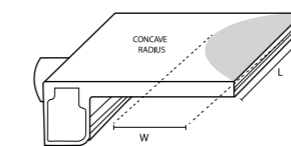

Radius Cut Compatible

**Important:** Waterfalls are to be used only with filtered water

Special stainless steel ornamental pool features designed and engineered with excellence and high precision. Made of AISI 316 stainless steel for massage and relaxation with best aesthetic looks. Available in mat or mirror polished finish. Selection of pump based on the low mentioned.

- Water curtain w/ width 400mm - connection size 1.5"
- Water curtain w/ width 600/500mm - connection size 2"

## Water Curtain Bali

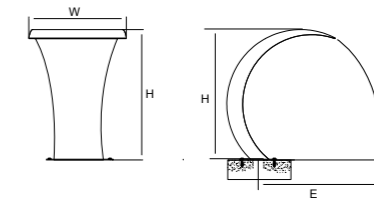

| Code     | Flow              | Height | Width  | Distance |
|----------|-------------------|--------|--------|----------|
| AISI 316 | (m <sup>3</sup> ) | H (mm) | W (mm) | E (mm)   |
| 0124040  | 16                | 400    | 400    | 420      |
| 0125050  | 18                | 500    | 500    | 440      |
| 0126060  | 21                | 600    | 600    | 550      |
| 0126070  | 21                | 700    | 600    | 630      |
| 0126080  | 21                | 800    | 600    | 840      |
| 0126090  | 21                | 900    | 600    | 880      |
| 01260100 | 21                | 1000   | 600    | 910      |
| 01260120 | 21                | 1200   | 600    | 970      |
| 01260140 | 21                | 1400   | 600    | 1030     |

## Cannon Jet Capri

Made of AISI 316 stainless steel with circular nozzle type mouth for maximum pressure, anchors required.



| Code     | Flow rate           | Weight | Volume            |
|----------|---------------------|--------|-------------------|
| AISI 316 | (m <sup>3</sup> /h) | (Kg)   | (m <sup>3</sup> ) |
| 14200029 | 20                  | 0.8    | 0.005             |

## Standard Shower Single Head

With Feetwisher

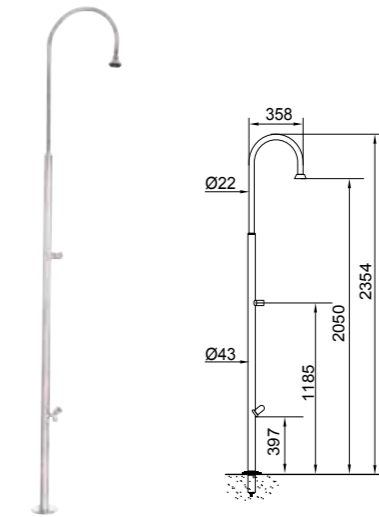

### Specifications

- Stainless steel tube AISI 304L Ø43 mm
- Shower taps: chrome-plated brass w/ trims
- Feetwisher: Taps chrome-plated brass

| Code     | Type   | Weight | Volume            |
|----------|--------|--------|-------------------|
|          |        | (kg)   | (m <sup>3</sup> ) |
| 00127040 | Manual | 5,1    | 0.04              |

## Oval Shower

With Feetwisher

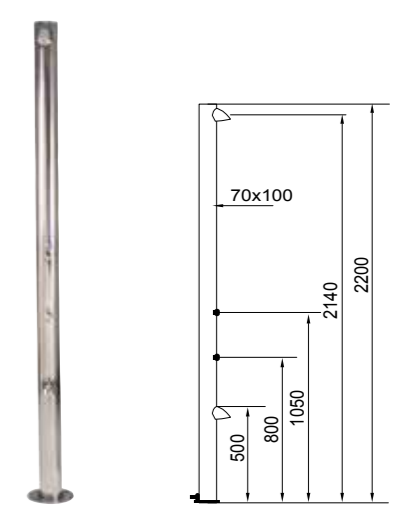

### Specifications

- Stainless steel tube AISI 304L Ø84 mm
- Shower taps: chrome-plated automatic valve w/ trims
- Feetwisher: Taps chrome-plated automatic valve with trim

| Code     | Type      | Weight | Volume            |
|----------|-----------|--------|-------------------|
|          |           | (kg)   | (m <sup>3</sup> ) |
| 00126045 | Automatic | 12     | 0.083             |

# Swimming pool gratings

## Over Flow Grating

Made of UV-protected high grade PP. 45 units in single linear meter.  
Standard color - White, any color can be custom made upon request.  
Available in 3 different heights - 22 mm, 24 mm and 30 mm.



| Code     | Height (mm)     | Width (mm) | Std Packing linear meter |
|----------|-----------------|------------|--------------------------|
| 01593718 | 22 end cut type | 195        | 10                       |
| 01593725 | 22 end cut type | 245        | 10                       |
| 01593730 | 22 end cut type | 295        | 10                       |
| 01593735 | 24              | 195        | 10                       |
| 01593740 | 24              | 245        | 10                       |
| 01593745 | 24              | 295        | 10                       |
| 01593747 | 30              | 195        | 10                       |
| 01593748 | 30              | 245        | 10                       |
| 01593749 | 30              | 295        | 10                       |

## Grating support profile

Grating Profile made of PP with internal dimensions 24 mm x 22 mm. Supplied in 2 m lengths. Suitable for 22 and 24 mm height grating. Color choice possible upon request.



| Code     | Size (internal mm) | Std Packing Linear meter |
|----------|--------------------|--------------------------|
| 01593777 | 24 x 22            | 24                       |

## 90° Corner Tiles

For over flow channels. Made of UV-protected high grade PP. Height - 24 mm



| Code       | Height (mm) | Width (mm) | Unit |
|------------|-------------|------------|------|
| 01596195-1 | 24          | 200        | 1    |
| 01596245-1 | 24          | 250        | 1    |

## Connection Box - ABS S.S. 316 Bronze models

Three models for connection boxes manufactured in ABS or SS 316 or Bronze. IP 65 class protection for ABS junction boxes and has 3 threaded outlets of 3/4" (PG 16), supplied with a set of electrical connectors and threaded couplers. Square type junction box standard size for the top lid : 130 x 130 mm.



| Code     | Code   | Outlets | Connection IP Rating |
|----------|--|---------|----------------------|
| 01592823 | JunctionBox ABS three 3/4" inlets/outlets, threaded  | 3       | 3/4" / IP65          |
| 0292020  | Square Connection Box SS 316 three 3/4" BSP threaded | 3       | 3/4" BSP / IP65      |



# Swimming pool Jets

## Suction Inlet ABS Threaded

Made in white ABS with 2" outer connection thread and Ø50 mm inner wall for concrete pools. Installed with female threaded wall conduits. Supplied with threaded plug of 1 1/2". Maximum pressure: 6 Bar



| Code       | Description                | Std packing | Volume<br>(m³) |
|------------|----------------------------|-------------|----------------|
| 01592827-2 | Suction Inlet ABS threaded | 24          | 0.020          |

## Floor Inlet ABS Slip Fit

Made in white ABS with Ø63 mm outer connection and Ø50mm inner wall and screws in stainless steel. Its unique design permits 360° dispersion of fresh water in the pool. Max. Recommended flow rate: 12m³/h, flow rate can be manually regulated with the help of an adjustable screw fitted on top centre of the inlet.



| Code     | Description              | Std packing | Volume<br>(m³) |
|----------|--------------------------|-------------|----------------|
| 01592825 | Floor Inlet ABS Slip Fit | 24          | 0.020          |

## Suction Inlet AISI 316

Suction inlet in polished stainless steel AISI 316 with outer thread 1 1/2". Length 50 mm, supplied with cover.



| Code     | Description            | Length<br>(mm) | Weight<br>(kg) | Volume<br>(m³) |
|----------|------------------------|----------------|----------------|----------------|
| 01592860 | Suction Inlet AISI 316 | 50             | 0.30           | 0.001          |

## Return Inlet ABS Threaded for Prefabricated

Made in white ABS with 2" outer connection thread and Ø50 mm inner wall for **prefab pools**. Supplied with gasket, screws and nut for liner fixing. Installed with female threaded wall conduits. Maximum Flow: 7 m³/hr. Recommended max. flow velocity 4 m/s.



| Code     | Description                          | Std packing | Volume<br>(m³) |
|----------|--------------------------------------|-------------|----------------|
| 01592836 | Return Inlet ABS Threaded for Prefab | 12          | 0.020          |

## Return Inlet AISI 316

Direction-adjustable return inlet in polished stainless steel AISI 316 with outer thread 1 1/2" and Ø20 mm eyeball. Recommended flow: 4.5 m³/hr.



| Code     | Description           | Length<br>(mm) | Weight<br>(kg) | Volume<br>(m³) |
|----------|-----------------------|----------------|----------------|----------------|
| 01592858 | Return Inlet AISI 316 | 50             | 0.30           | 0.001          |

## Anti-Vortex Drain Grille AISI 316

Support ring and circular grille Ø220mm made of stainless steel AISI 316. Supplied with grille fixing screws. Recommended flow rate 14 m³/hr.



| Code     | Description                      | Size<br>(mm) | Std packing | Weight<br>(kg) |
|----------|----------------------------------|--------------|-------------|----------------|
| 10532115 | Anti-Vortex Drain Grille AISI 31 | 220          | 1           | 1.5            |

## Adjustable Jet Ø50x50

Made of white ABS for perfect gluing to PVC pipes. Ø50mm water inlet and air inlet. Flow - 4.5 m³/hr. Unique design permits for a combination of air and water massage by way of a venture system. Atmospheric Pressure at 0.8 bar. Available with stainless steel AISI 316 trim.



| Code     | Description                  | Weight<br>(kg) | Volume<br>(m³) | Std Packing |
|----------|------------------------------|----------------|----------------|-------------|
| 00590050 | JET 50X50 ABS                | 6.92           | 0.027          | 25          |
| 00590057 | JET 50X50 ABS with S.S. Trim | 9.92           | 0.028          | 25          |

## Adjustable Jet Ø 1.5"x1.5"

Made of White ABS for perfect gluing to PVC pipes. Ø1.5" water inlet and air inlet. Flow - 4 m³/hr. Unique design permits for a combination of air and water massage by way of a venture system. Atmospheric Pressure at 0.8 bar. Available with stainless steel AISI 316 trim.



| Code     | Description                     | Weight<br>(kg) | Volume<br>(m³) | Std Packing |
|----------|---------------------------------|----------------|----------------|-------------|
| 00590055 | JET 1.5 X1.5 ABS                | 5.82           | 0.026          | 25          |
| 00590059 | JET 1.5 X1.5 ABS with S.S. Trim | 9.02           | 0.028          | 25          |



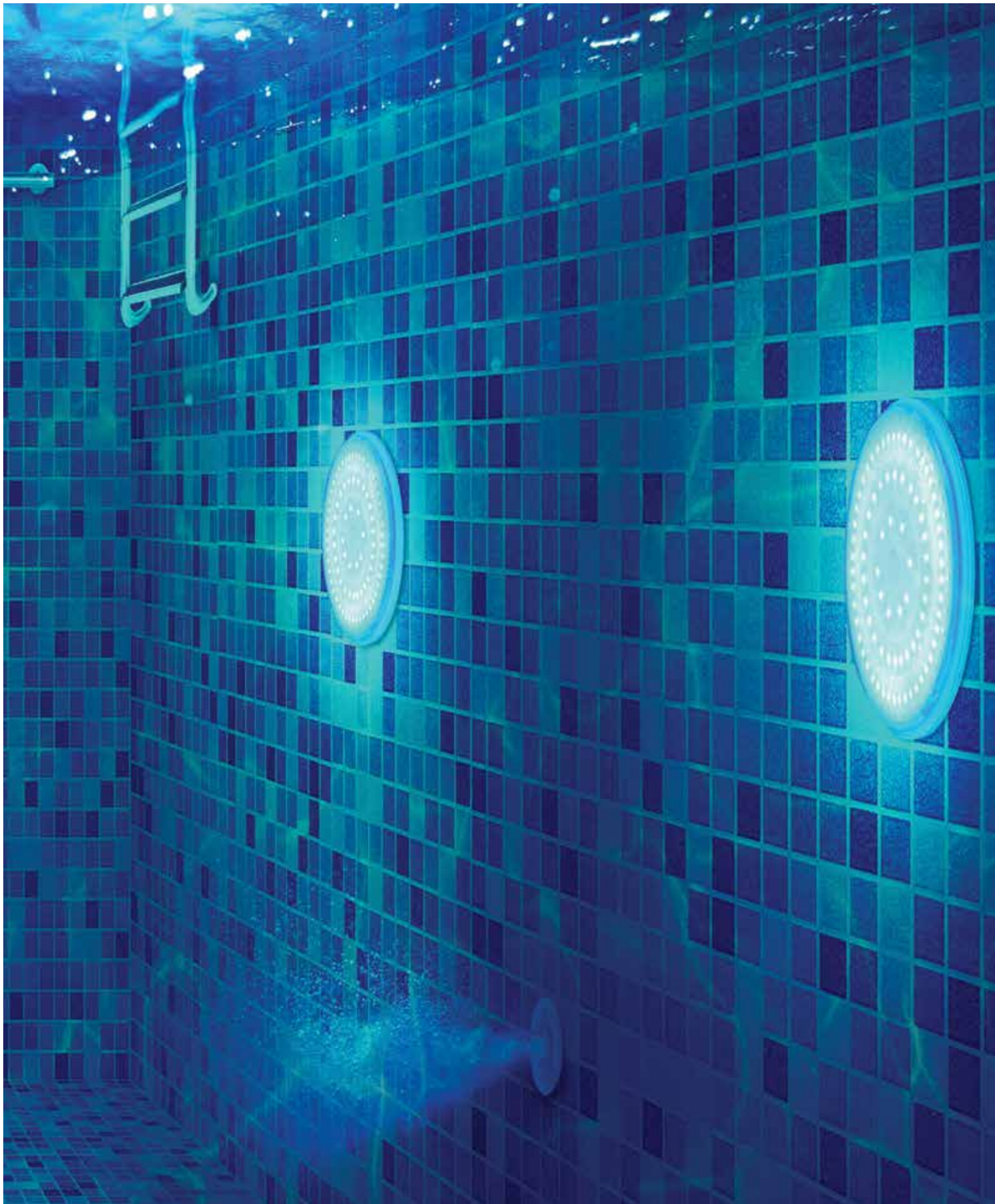

# Swimming pool lights

## Spectra-Slim LED Lighting ABS High Power Slim LED

### Spectra-Slim LED Panel ABS Lighting

Super bright Ultra Slim LED panel underwater lights for swimming pool and spa. Made of ABS with resin filled bulbs which are 100% acid-proof, alkali-proof and UV resistant. Low power consumption, high stability, IP68 waterproof. Models available in RGB, Cool White, Warm White and Blue colour. Supplied with 3mtr 2 Core 2x1.0 mm<sup>2</sup> cable for all models. RGB lights get synchronized using Atecpool LED modulators / remote control with colour sequence arranged in 16 programs. ABS frame is compatible to any size niches using installation adaptor kit supplied along with the lights.

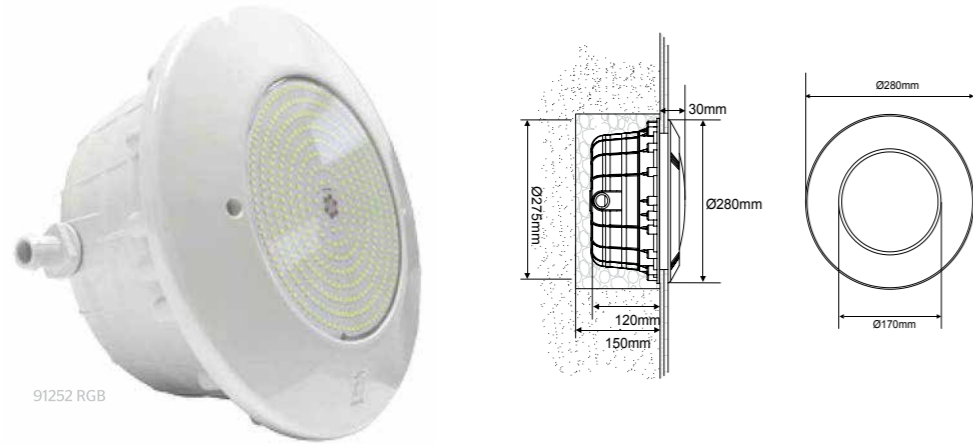

### Concrete, Liner and Pre-fabricated pools - Easy installation

Spectra-Slim LED panel ABS lighting can be used for concrete, liner and pre-fabricated pools. Thanks to the installation adaptor kit supplied along with the lights make it possible to install in concrete, liner or pre-fabricated pools.

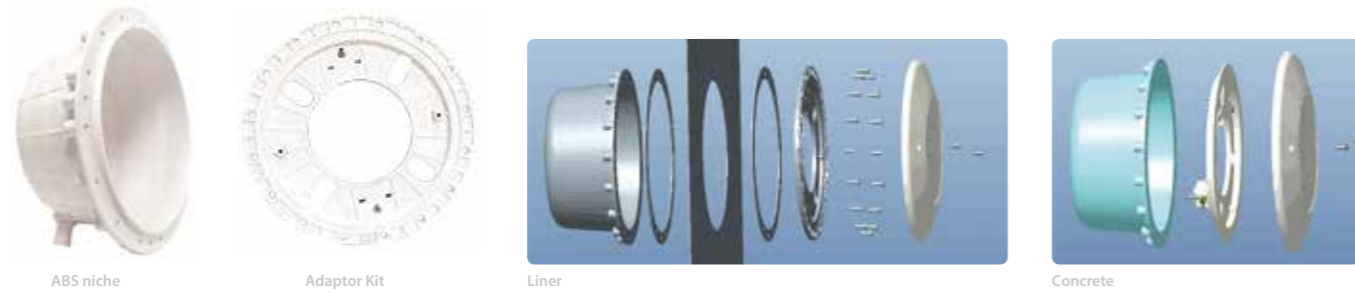

### Spectra-Slim LED Panel Bulb

Constant current driving, resin filled LED have consistent color and brightness. High stability and long life span.

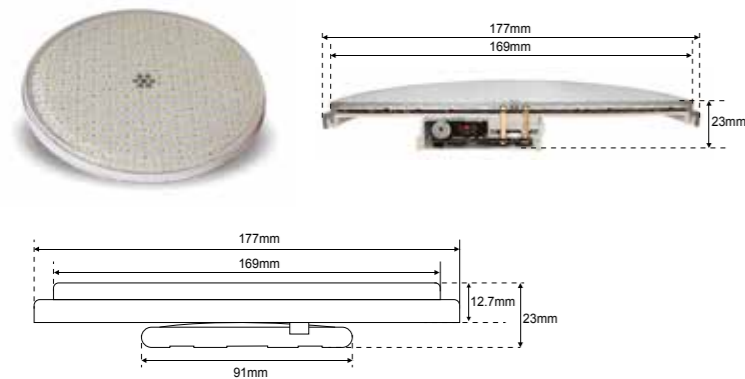

### Spectra-Slim LED Panel Bulb - Specification

**RGB Bulb** RGB 16 modes  
16 programs with synchronization capability  
Power output in 3 models: 18W / 30W / 55W

**Single Color Bulb Temperature** 6500K / 2700K / Single Blue  
Power output in 3 models: 21W / 33W / 60W  
Standard input voltage: 12V AC / DC

## Spectra-Slim LED Lighting S.S. 316 High Power Slim LED

### Spectra-Slim S.S. 316 Lighting

Super bright Ultra Slim LED panel underwater lights for swimming pool and spa, frame made of stainless steel AISI 316 and ABS niche. Supplied with resin filled bulbs which are 100% acid-proof, alkali-proof and UV resistant. Low power consumption, high stability, IP68 waterproof. Models available in RGB, Cool White, Warm White and Blue colour. Supplied with 3mtr 2 Core 2x1.0 mm<sup>2</sup> cable for all models. RGB lights get synchronized using LED modulators/ remote control with colour sequence arranged in 16 programs. S.S. frame is compatible to any size niches using installation adaptor kit supplied along with the lights.

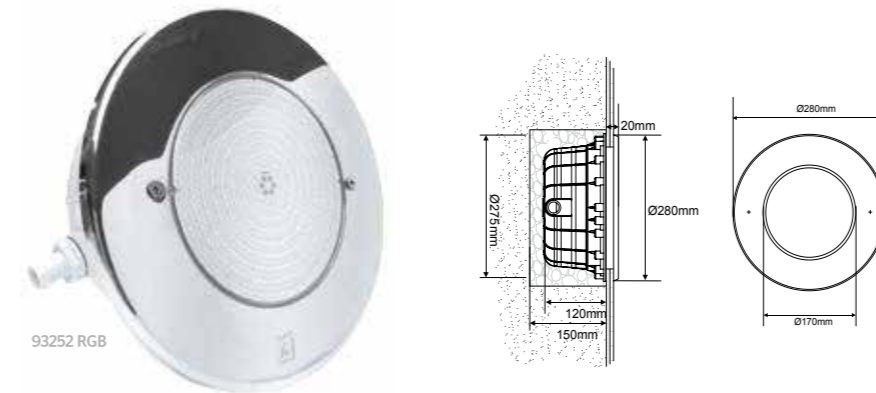

### Concrete, Liner and Pre-fabricated pools - Easy installation

Atecpool Spectra-Slim LED panel S.S. 316 lighting can be used for concrete, liner and pre-fabricated pools. Thanks to the installation adaptor kit supplied along with the lights make it possible to install in concrete, liner or pre-fabricated pools.

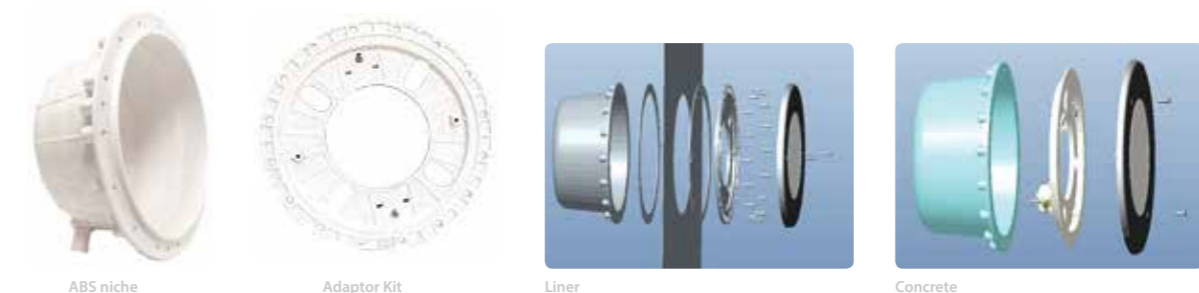

### Atecpool Spectra-Slim LED Panel Bulb

Constant current driving, resin filled LED have consistent color and brightness. High stability and long life span.

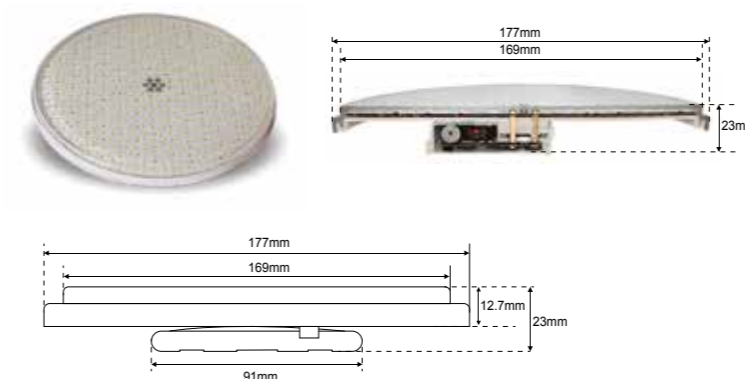

### Spectra-Slim LED Panel Bulb - Specification

**RGB Bulb** - RGB 16 modes  
16 programs with synchronization capability  
Power output in 3 models: 18W / 30W / 55W

**Single Color Bulb Temperature** 6500K / 2700K / Single Blue  
Power output in 3 models: 21W / 33W / 60W  
Standard input voltage: 12V AC / DC



# Swimming pool lights

## Spectra Extra Flat LED S.S. 316 Lighting

LED underwater light for swimming pool and spa. Lamps fully filled with resin, completely waterproof, wall mounted, nicheless with S.S frame. Models available in RGB, Cool White, Warm White and Blue colour. RGB lights works with LED modulator with remote control system for synchronization.

### Specifications

- Electrical Connection: 12V AC
- Complete with 2 core 2X1.0 mm<sup>2</sup> cable
- Construction: Moulded housing S.S. AISI 316
- Protection Class: IP68
- Lamp life: approx. 60,000 hrs
- Supplied with 4 mtr cable
- 16 programs with synchronization capability

### Features

- Quality Resin filled lamps provides 100% waterproof assurance.
- Consumes 90% less energy than traditional lighting.
- High temperature protection guarantees the long life of LEDs.
- True PWM Technology is adopted.
- No niche, easy installation.
- Lights can be wired to any 12V/AC transformer.

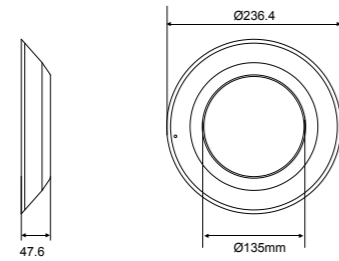

### LED Modulator



**2 CORE connection**  
-WITH REMOTE CONTROL



| Code  | Description                           | Power / Voltage | Lumen   | Color Temperature |
|-------|---------------------------------------|-----------------|---------|-------------------|
| 20524 | Spectra Extra Flat RGB S.S 316        | 18W / 12 VAC    | 925 lm  | RGB 16 Mode       |
| 20528 | Spectra Extra Flat Cool White S.S 31  | 21W / 12 VAC    | 2100 lm | 6500K             |
| 20532 | Spectra Extra Flat Warm White S.S 316 | 21W / 12 VAC    | 1920 lm | 2700K             |
| 20536 | Spectra Extra Flat Blue S.S 316       | 21W / 12 VAC    | 470 lm  | Single Blue       |

## Lumina Extra Flat 199 LED ABS Lighting

Lumina Extra Flat LED ABS underwater light for wall mounting with 199 LED offering sixteen colour changing modes. The lights can be wired to any 12V/AC transformer. Models available in RGB, Cool White, Warm White and Blue colour. RGB lights works with LED modulator with remote control system for synchronization.

### Specifications

- Electrical Connection: 12V AC
- Complete with 2 core 2X1.0 mm<sup>2</sup> cable
- Supplied material of construction: ABS
- Protection Class: IP68
- Lamp life: approx. 30,000 hrs
- Supplied with 2 mtr cable
- 16 programs with synchronization capability

### Features

- UV protection.
- Consumes 90% less energy than traditional lighting.
- Tempered Protection Glass.
- No niche, easy installation.
- Constant-current driver to the LED.
- Low power consumption, low heat dissipation.

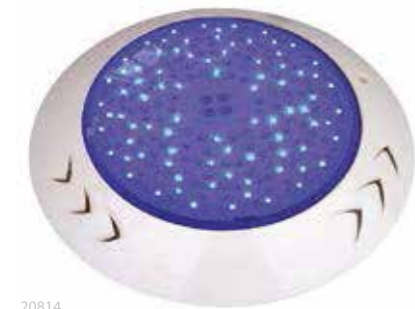

| Code  | Description                              | Power / Voltage | Lumen  |
|-------|--|-----------------|--------|
| 20814 | Lumina Extra Flat 199 LED RGB ABS        | 11W / 12 VAC    | 550 lm |
| 20818 | Lumina Extra Flat 199 LED Cool White ABS | 12W / 12 VAC    | 840 lm |
| 20822 | Lumina Extra Flat 199 LED Warm White ABS | 12W / 12 VAC    | 680 lm |
| 20826 | Lumina Extra Flat 199 LED Blue ABS       | 12W / 12 VAC    | 260 lm |

# Lumina Mini Spa LED Lighting ABS with S.S. faceplate

## Lumina Mini Spa LED Panel Lighting - ABS with S.S. trim & ABS

Lumina Mini SPA lighting in ABS with quick connections to 2" threaded wall conduit. Fully resin filled panel LED offering sixteen colour changing function in RGB mode. Light available in RGB, Cool White, Warm White and Blue colour options. RGB Lights are synchronized using LED Modulators with remote control system. Maximum power consumption of 7W and can be connected to a 12V/AC transformer.

### Specifications

- Electrical Connection: 12V AC
- Complete with 2 core 2x10 mm cable
- Material of construction: ABS
- Protection Class: IP68
- Lamp Life: Approx. 60,000 hrs
- Supplied with 2 mtr cable
- 16 programs with synchronized capability

### Features

- Consumes 90% less energy than traditional lighting.
- Eco-friendly, no radiation.
- Low power consumption, low heat dissipation.
- Light transmission rate up to 92%.
- PWM technology adopted
- 2" threaded wall conduits suitable for quick connections Lumina Mini ABS Spa Lights

## Lumina Mini Spa LED Panel Lighting - ABS with S.S. faceplate

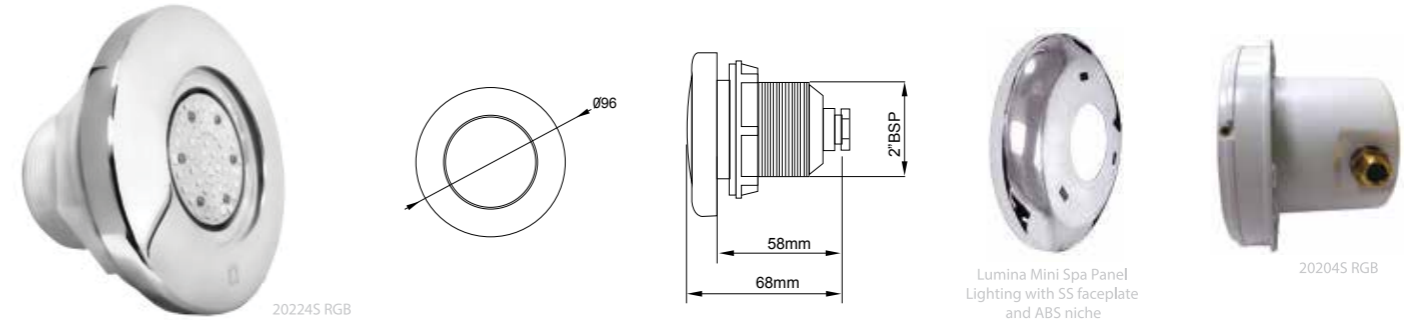

| Code          |            |   | Ø100mm          |            |
|---------------|------------|---|-----------------|------------|
| Threaded Type | Niche Type | Model   | Power / Voltage | Lumen (lm) |
| 20224S RGB    | 20204S RGB | Lumina Mini LED ABS with S.S. trim RGB        | 6W / 12V        | 350        |
| 20224S CW     | 20205S CW  | Lumina Mini LED ABS with S.S. trim Cool White | 7W / 12V        | 600        |
| 20224S WW     | 20206S WW  | Lumina Mini LED ABS with S.S. trim Warm White | 7W / 12V        | 560        |
| 20224S BLU    | 20207S BLU | Lumina Mini LED ABS with S.S. trim Blue       | 7W / 12V        | 165        |

## Lumina Mini Spa LED Panel Lighting - ABS

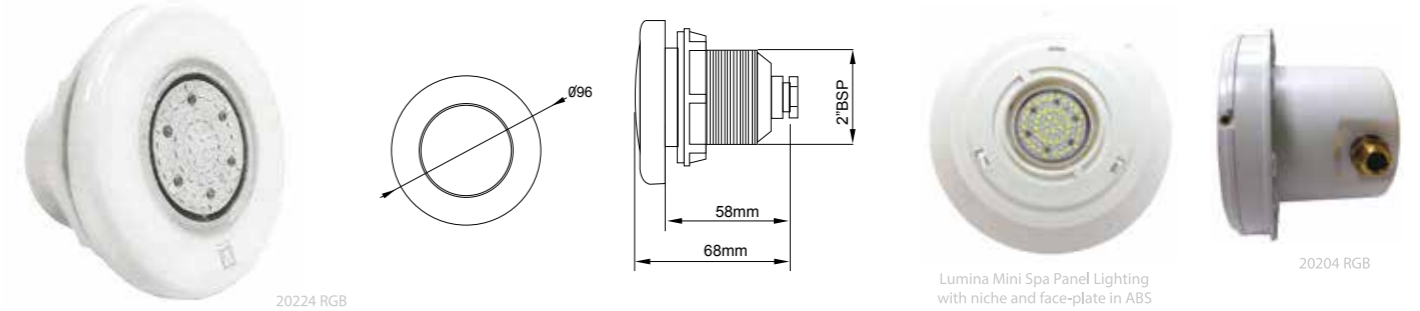

| Code          |            |                                | Ø163mm          |            |
|---------------|------------|--------------------------------|-----------------|------------|
| Threaded Type | Niche Type | Model                          | Power / Voltage | Lumen (lm) |
| 20224 RGB     | 20204 RGB  | Lumina Mini LED ABS RGB        | 6W / 12V        | 350        |
| 20224 CW      | 20205 CW   | Lumina Mini LED ABS Cool White | 7W / 12V        | 600        |
| 20224 WW      | 20206 WW   | Lumina Mini LED ABS Warm White | 7W / 12V        | 560        |
| 20224 BLUE    | 20207 BLUE | Lumina Mini LED ABS Blue       | 7W / 12V        | 165        |

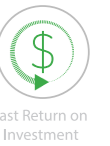

# Swimming pool lights

## Lumina Mini Spa LED Lighting Stainless Steel 316

### Lumina Mini Spa LED Panel Lighting S.S. 316

Lumina Mini SPA lighting in stainless steel AISI 316 construction. Quick push-fit connections to solvent weld wall conduit Ø63 mm. Fully resin filled panel LED offering sixteen colour changing function in RGB mode. Light available in RGB, Cool White, Warm White and Blue colour options. RGB Lights are synchronized using LED Modulators with remote control system. Maximum power consumption of 7W and can be connected to a 12V/AC transformer.

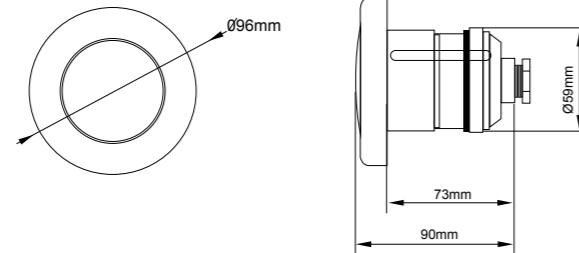

Easy Colour Picker



International Safety Tested  
IEC EN 60598-2:18



Fast Return on Investment

### Specifications

- Electrical Connection: 12V AC
- Complete with 2 core 2x10 mm<sup>2</sup> cable
- Material of construction: SS AISI 316
- Protection Class: IP68
- Lamp Life: Aprox. 60.000 hrs
- Supplied with 2 mtr cable
- 16 programs with synchronized capability

### Features

- Consumes 90% less energy than traditional lighting.
- Eco-friendly, no radiation.
- Low power consumption, low heat dissipation.
- Light transmission rate up to 92%.
- PWM technology adopted
- No niche, solvent weld wall conduits Ø63 mm suitable for quick push-fit connections Lumina Mini S.S. Lights

### Photometrics - 20444 CW 7W 5700K LED / 12V AC

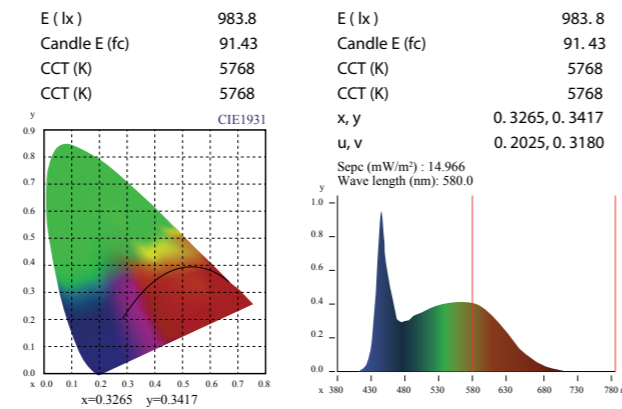

| Code     | Model                              | Power / Voltage | Lumen (lm) | Color Temperature |
|----------|------------------------------------|-----------------|------------|-------------------|
| 20444RGB | Lumina Mini Spa LED S.S RGB        | 6W / 12V        | 350        | RGB 16 Mode       |
| 20444CW  | Lumina Mini Spa LED S.S Cool White | 7W / 12V        | 600        | 6500K             |
| 20444WW  | Lumina Mini Spa LED S.S Warm White | 7W / 12V        | 560        | 2700K             |
| 20444B   | Lumina Mini Spa LED S.S Blue       | 7W / 12V        | 165        | Single Blue       |

### Atecpool Vitrage 3 LED Underwater Light

Vitrage 3 LED Light, complete body construction in AISI 316 Stainless Steel supplied with an ABS niche specially designed for your Pool & Spa. Waterproof IP68. Available in cool white, warm white, blue and RGB.

### Specifications

- Made of Stainless Steel AISI 316
- Glass: Step tempered glass T=8mm
- Cable gland: IP68 PG11
- Driver: constant current output
- Single colour LED = 1 circuit output: RGB 3 in 1 LED=3 circuit output
- Application environment: Temperature of water between 20°C - 40°C less than 1 meter depth
- Power cable: H07RN-F 2X10 mm L=3m (for single colour)H07RN-F 4X0.75 mm L=3m (RGB)
- Mounting sleeve: PVC with IP68 cable & conduit gland



ATZ1973 CW

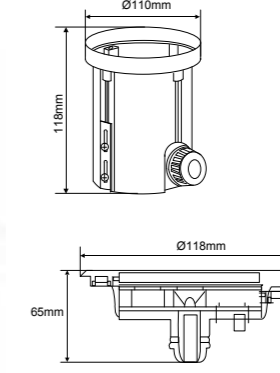

### Photometric Data ATZ1973 CW - 6000K, 30°

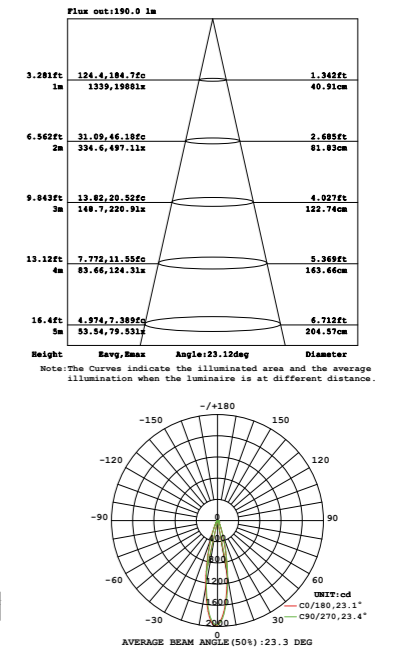

| Code        | Description              | Voltage | Power | Beam Angle | Lumen (lm) | Color Temp       |
|-------------|--------------------------|---------|-------|------------|------------|------------------|
| ATZ1973 CW  | Vitrage 3 LED Cool White | 12V AC  | 3x3 W | 30°        | 720        | Cool White 6000K |
| ATZ1973 WW  | Vitrage 3 LED Warm White | 12V AC  | 3x3 W | 30°        | 640        | Warm White 3000K |
| ATZ1973 B   | Vitrage 3 LED Blue       | 12V AC  | 3x3 W | 30°        | 220        | Single Blue      |
| ATZ1973 RGB | Vitrage 3 LED RGB        | 24V DC  | 3x3 W | 30°        | 450        | RGB 14 Modes     |

### Atecpool Vitrage 9 LED Underwater Light

Vitrage 9 LED Light, complete body construction in AISI 316 Stainless Steel, supplied with an ABS niche specially designed for your Pool & Spa. Waterproof IP68. Available in cool white, warm white, blue and RGB.

### Specifications

- Made of Stainless Steel AISI 316
- Glass: Step tempered glass T=8mm
- Cable gland: IP68 PG11
- Driver: constant current output
- Power Cable: H07RN-F 2X10 mm L=3 (for single colour) H07RN-F 4X0.75 mm L=3m (RGB)
- Single colour LED = 1 circuit output: RGB 3 in 1 LED = 3 circuit output
- Application environment: Temperature of water between 20°C - 40°C less than 1 meter depth
- Mounting sleeve: PVC with IP68 cable & conduit gland



ATZ1202 CW

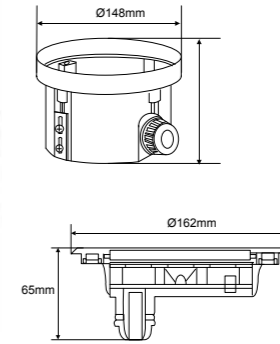

### Photometric Data ATZ1202 CW - 6000K, 30°

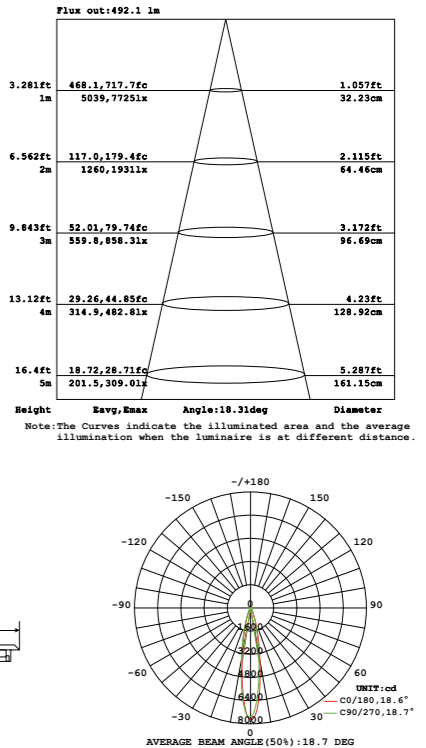

| Code        | Description              | Voltage | Power | Beam Angle | Lumen (lm) | Color Temp       |
|-------------|--------------------------|---------|-------|------------|------------|------------------|
| ATZ1202 CW  | Vitrage 9 LED Cool White | 12V AC  | 9x3 W | 30°        | 2160       | Cool White 6000K |
| ATZ1202 WW  | Vitrage 9 LED Warm White | 12V AC  | 9x3 W | 30°        | 1880       | Warm White 3000K |
| ATZ1202 B   | Vitrage 9 LED Blue       | 12V AC  | 9x3 W | 30°        | 660        | Single Blue      |
| ATZ1202 RGB | Vitrage 9 LED Full RGB   | 24V DC  | 9x3 W | 30°        | 1450       | RGB 14 Modes     |

# Swimming pool lights

## Atecpool Vitrage 12 LED Underwater Light

Vitrage 12 LED Light, complete body construction in AISI 316 Stainless Steel, supplied with an ABS niche specially designed for your Pool & Spa. Waterproof IP68. Available in cool white, warm white, blue and RGB.

### Specifications

- Made of Stainless Steel AISI 316
- Glass: Step tempered glass T=8mm
- Cable gland: IP68 PG11
- Driver: constant current output
- Single colour LED = 1 circuit output  
RGB 3 in 1 LED=3 circuit output
- Application environment: Temperature of water between 20°C - 40°C less than 1 meter depth.
- Power cable: HO7RN-F 2X1.0 mm L=3m (for single colour)HO7RN-F 4X0.75 mm L=3m (RGB)
- Mounting sleeve: PVC with IP68 cable & conduit gland



ATZ1811 CW

### Photometric Data ATZ1811 CW - 6000K, 30°

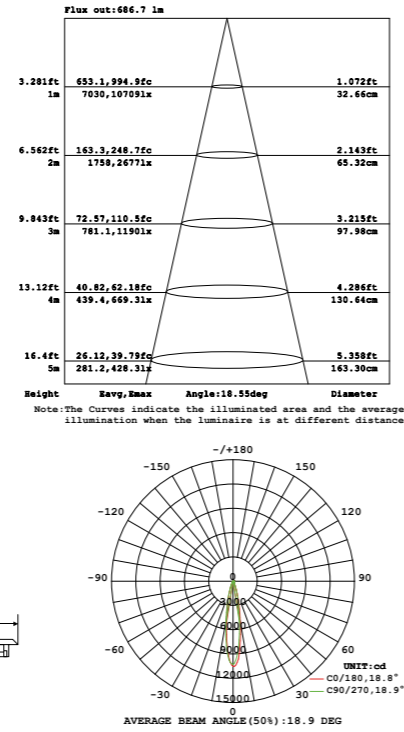

| Code        | Description               | Voltage | Power  | Beam Angle | Lumen (lm) | Color Temp       |
|-------------|---------------------------|---------|--------|------------|------------|------------------|
| ATZ1811 CW  | Vitrage 12 LED Cool White | 12V AC  | 12x3 W | 30°        | 3300       | Cool White 6000K |
| ATZ1811 WW  | Vitrage 12 LED Warm White | 12V AC  | 12x3 W | 30°        | 2600       | Warm White 3000K |
| ATZ1811 B   | Vitrage 12 LED Blue       | 12V AC  | 12x3 W | 30°        | 790        | Single Blue      |
| ATZ1811 RGB | Vitrage 12 LED Full RGB   | 24V DC  | 12x3 W | 30°        | 1750       | RGB 14 Modes     |

## Atecpool Safety Step-down Transformers IP65

Special transformer encapsulated in cast resin material protected by a plastic cover-box. Available from 100W up to 600W with output voltage of 12VAC, variable voltage of 13/14/15/16VAC. Variable voltage transformers resist the voltage drop between the transformer and the connection box to suit a range of different lengths and sizes of cable. Wall mounting. Protection class: IP65 50/60 Hz.



01983100

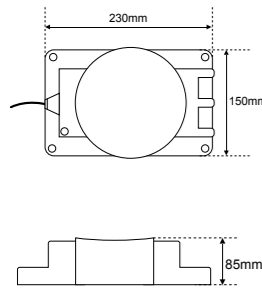

| Code   | Primary     | Secondary  | Power | Dimension L/W/D (mm) |
|--|-------------|------------|-------|----------------------|
| <b>105W / 12VAC Toroidal Transformer IP65</b>              |             |            |       |                      |
| 01983100   | 220V-240VAC | 12VAC      | 105W  | 230 x 150 x 85       |
| <b>300W / 12VAC Toroidal Transformer IP65</b>              |             |            |       |                      |
| 01983300   | 220V-240VAC | 12VAC      | 300W  | 230 x 150 x 85       |
| <b>400W / 12VAC Toroidal Transformer IP65</b>              |             |            |       |                      |
| 01983400   | 220V-240VAC | 12VAC      | 400W  | 230 x 150 x 85       |
| <b>600W / 12VAC Toroidal Transformer IP65</b>              |             |            |       |                      |
| 01983600   | 220V-240VAC | 12VAC      | 600W  | 230 x 150 x 85       |
| <b>105W / 14 - 16VAC Variable Voltage Transformer IP65</b> |             |            |       |                      |
| 01984100   | 220V-240VAC | 14 - 16VAC | 105W  | 230 x 150 x 85       |
| <b>300W / 14 - 16VAC Variable Voltage Transformer IP65</b> |             |            |       |                      |
| 01984300   | 220V-240VAC | 14 - 16VAC | 300W  | 230 x 150 x 85       |
| <b>400W / 14 - 16VAC Variable Voltage Transformer IP65</b> |             |            |       |                      |
| 01984400   | 220V-240VAC | 14 - 16VAC | 400W  | 230 x 150 x 85       |
| <b>600W / 14 - 16VAC Variable Voltage Transformer IP65</b> |             |            |       |                      |
| 01984600   | 220V-240VAC | 14 - 16VAC | 600W  | 230 x 150 x 85       |

# Atecpool LED Modulator Control Panel with remote control

## LED Modulator with remote control

Suitable for synchronizing RGB colour changing LED lights. Atecpool LED Modulator available in 2 core and 4 core cable connection. 2 core LED Modulator R2007 used with Radiant PAR56, Spectra, Spectra High Power, Lumina and Lumina Mini colour changing RGB LED lights. Advanced feature of this panel is that it can synchronize RGB LED lights using 2 core cable. This makes it possible to use in existing pools that are already installed with 2 core halogen lamps.

4 core LED Modulator RKP001 used with Vitrage, Starry and Ladder colour changing RGB lights. Apart from selecting and synchronizing the colour, the 4 core modulator enables the user to control the sequence, pattern or speed of the light changing or to simply select a constant colour. The panel is designed to be wall mounted.



R2007



**2 CORE connection**  
- WITH REMOTE CONTROL -

### Specifications

- Includes port for input power from mains
- Standard design includes 12V / 200W transformer
- Suitable for 2 core electrical cable
- Two Input ports for cables from individual lights
- Number of lights can be enhanced on prior request at additional cost
- The entire Radiant, Spectra, Lumina and Lumina Mini range lighting can be controlled by single remote control.
- Panel available with and without transformer. Those without transformer should be connected to step-down voltage of 12V AC

| Code  | Description                                    | Power/Voltage        |
|-------|--|----------------------|
| R2007 | Atecpool LED Modulator 2 core with transformer | 200W/12V AC (output) |
| R2009 | Atecpool LED Modulator 2 core w/o transformer  | 12V AC (input)       |

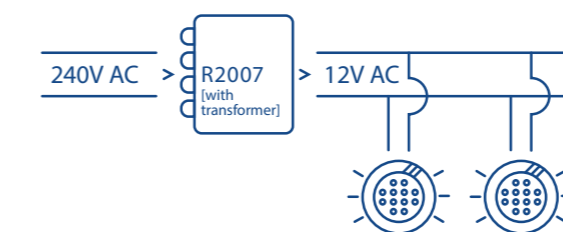

RKP001

### Specifications

- 4 Core Connection / DC Voltage
- Long remote control distance upto 40 meters
- Wifi remote control on special request
- The entire Vitrage and Ladder LED RGB lighting can be controlled by single remote control
- RGB LED Modulator up to 20 LED lights 4 cable selection
- Output voltage 12/24V DC for RGB 4 cable selection
- LED Modulator for Starry LED with 5V DC output
- Number of lights can be enhanced on prior request at additional cost

| Code   | Description                   | Voltage   |
|--------|-------------------------------|-----------|
| RKP001 | Atecpool LED Modulator 4 core | 12/24V DC |
| RKP005 | Atecpool LED Modulator Starry | 5V DC     |

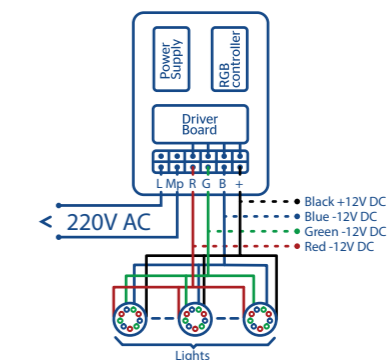

## TECHNICAL FEATURES

### PORCELAIN TILES (B1a - GL) :

Porcelain tiles are manufactured using pure, selectively imported raw materials mixed using the most advanced extraction and sorting techniques; they are obtained with a production process similar to that of single-fired tiles.

The resulting product is top-quality porcelain tile, obtained by raw materials wet grinding, followed by partial drying by spraying, silo storage to allow homogenization of properties, and pressing with highly efficient hydraulic presses up to specific pressures more than 500 kg/cm<sup>2</sup>. The high pressure combined with high firing temperature exceeding 1200 °C results in highly compact & strong ceramic surface with very low water absorption (lower than 0.4% according to UNI EN ISO 10545-3) and extremely high mechanical resistance (average value exceeding 40 N/mm<sup>2</sup> according to UNI EN ISO 10545-4).

Thanks to their low porosity, these porcelain tiles are frost-proof and rated as belonging to the B1a GL class according to the International Standard ISO 13006 and European Standard UNI EN 14411 which requires water absorption ≤ 0.5%.

The MoR (modulus of rupture) in accordance with UNI EN ISO 10545-4 results to 40 N/mm<sup>2</sup> while the required value is 35 N/mm<sup>2</sup>. RAK Ceramics porcelain tiles are available in a wide range of designs, sizes and finishes.

















#### ADVICE ON LAYING

Although our porcelain tiles can be installed using traditional cement mortars, we advise using modern adhesives. While installing on wall, the two-layer spreading system is recommended to perfectly wet the back of the tile.

Quickly dipping each tile in water before installation will remove any dust on the back of the tile for perfect adhesion. Do not wet the tiles if you are using vinyl, acrylic resin adhesives or two-component organic-solvent based adhesive.

It is advisable to incorporate suitable shrinkage - flexion joints (movement/ expansion joints) when installing on large floors: the joints should never be spaced more than 4 - 5 linear meters apart indoors and 3 linear meters apart outdoors. Be careful while using strong coloured grouts as they might leave stains on the surface of the tiles that may be difficult to remove later.

### TECHNICAL CHARACTERISTICS - PORCELAIN TILES (B1a - GL)

| Test Description   | Standard Test Method | International Standard ISO 13006     | RAK Ceramics Specifications |                           |
|--|----------------------|--------------------------------------|-----------------------------|---------------------------|
|  |                      |                                      | (Rectified)                 | (Unrectified)             |
|  Length & Width                   | BS EN ISO 10545-2    | +/- 0.6%                             | +/- 0.1%                    | +/- 0.3%                  |
|  Thickness                        | BS EN ISO 10545-2    | +/-5.0%                              | +/- 5.0%                    | +/- 5.0%                  |
|  Rectangle Squareness             | BS EN ISO 10545-2    | +/- 0.5%                             | +/- 0.2%                    | +/- 0.4%                  |
|  Straightness of sides            | BS EN ISO 10545-2    | +/- 0.5%                             | +/- 0.2%                    | +/- 0.3%                  |
|  Surface Flatness                 | BS EN ISO 10545-2    | +/- 0.5%                             | +/- 0.3%                    | +/- 0.3%                  |
|  Water Absorption                 | BS EN ISO 10545-3    | <=0.5%                               | <=0.4%                      | <=0.4%                    |
|  Modulus of Rupture              | BS EN ISO 10545-4    | >=35 N/mm <sup>2</sup>               | >=40 N/mm <sup>2</sup>      | >=40 N/mm <sup>2</sup>    |
|  Breaking Strength              | BS EN ISO 10545-4    | >=1300N                              | >=1600N                     | >=1600N                   |
|  Resistance to surface abrasion | BS EN ISO 10545-7    | Manufacturer to state Abrasion Class | PEI Class 2 -5              | PEI Class 2 -5            |
|  Linear Thermal Expansion       | BS EN ISO 10545-8    | <=9x10 <sup>-6</sup> /°C             | <=7x10 <sup>-6</sup> /°C    | <=7x10 <sup>-6</sup> /°C  |
|  Resistance to Thermal Shock    | BS EN ISO 10545-9    | No visible defect                    | No visible defect           | No visible defect         |
|  Crazing Resistance             | BS EN ISO 10545-11   | No crazing                           | No crazing                  | No crazing                |
|  Frost Resistance               | BS EN ISO 10545-12   | No visible damage                    | No visible damage           | No visible damage         |
|  Resistance to chemicals        | BS EN ISO 10545-13   | No visible defect                    | No visible defect           | No visible defect         |
|  Resistance to stains           | BS EN ISO 10545-14   | Manufacturer to state class          | Stain removed Min.class 4   | Stain removed Min.class 4 |
|  Colour Resistance to UV Light  | DIN 51094            | No change in color                   | No change in color          | No change in color        |

**Note :** Shade variation across the batches is inherent to the manufacturing process and the pre-laying colour comparison is recommended

## TECHNICAL FEATURES

### FULL BODY PORCELAIN TILES (BIA - UGL) :

Full body porcelain tiles are manufactured using pure, selectively imported raw materials mixed using the most advanced extraction and sorting techniques; they are obtained with a production process similar to that of single-fired tiles.

The resulting product is top-quality porcelain tile, obtained by raw materials wet grinding, followed by partial drying by spraying, silo storage to allow homogenization of properties, and pressing with highly efficient hydraulic presses up to specific pressures more than 500 kg/cm<sup>2</sup>. The high pressure combined with high firing temperature exceeding 1200 °C results in highly compact & strong ceramic surface with very low water absorption (lower than 0.1% according to UNI EN ISO 10545-3) and extremely high mechanical resistance (average value exceeding 40 N/mm<sup>2</sup> according to UNI EN ISO 10545-4).

Full body porcelain are suitable for heavy traffic areas as they are characterized by a deep abrasion resistance (equal to 150 mm<sup>3</sup> of removed material, as opposed to the 175 mm<sup>3</sup> provided for by the UNI EN ISO 10545-6 standard).

Thanks to their low porosity, these tiles are frost-proof and rated as belonging to the BIa UGL class according to the International Standard ISO 13006 and European Standard UNI EN 14411 which requires water absorption ≤ 0.5%.

Chemical acid and base resistance (UNI EN ISO 10545-13) makes full body porcelain tiles suitable for environments where aggressive chemicals are used, e.g. food processing factories, hospitals, chemical or pharmaceutical plants. The full bod porcelain tiles are available in a wide range of sizes and surfaces (slip-resistant finish also available).















#### ADVICE ON LAYING

Although our full bod porcelain tiles can be installed using traditional cement mortars, we advise using modern adhesives. For large sizes over 40x40cm, outdoor and wall installations, the two-layer spreading system is recommended to perfectly wet the back of the tile.

Quickly dipping each tile in water before installation will remove any dust on the back of the tile for perfect adhesion. Do not wet the tiles if you are using vinyl, acrylic resin adhesives or two-component organic-solvent based adhesive.

It is advisable to incorporate suitable shrinkage - flexion joints (movement/ expansion joints) when installing on large floors: the joints should never be spaced more than 4 - 5 linear meters apart indoors and 3 linear meters apart outdoors. Be careful while using strong coloured grouts as they might leave stains on the surface of the tiles that may be difficult to remove later.

### TECHNICAL CHARACTERISTICS - FULL BODY PORCELAIN TILES (BIA - UGL)

| Test Description   | Standard Test Method | International Standard ISO 13006     | RAK Ceramics Specifications          |                                      |
|--|----------------------|--------------------------------------|--------------------------------------|--------------------------------------|
|  |                      |                                      | (Rectified)                          | (Unrectified)                        |
|  <b>Length &amp; Width</b>              | BS EN ISO 10545-2    | +/- 0.6%                             | +/- 0.1%                             | +/- 0.3%                             |
|  <b>Thickness</b>                       | BS EN ISO 10545-2    | +/- 5.0%                             | +/- 5.0%                             | +/- 5.0%                             |
|  <b>Rectangle Squareness</b>            | BS EN ISO 10545-2    | +/- 0.5%                             | +/- 0.2%                             | +/- 0.4%                             |
|  <b>Straightness of sides</b>           | BS EN ISO 10545-2    | +/- 0.5%                             | +/- 0.2%                             | +/- 0.3%                             |
|  <b>Surface Flatness</b>                | BS EN ISO 10545-2    | +/- 0.5%                             | +/- 0.2%                             | +/- 0.3%                             |
|  <b>Water Absorption</b>                | BS EN ISO 10545-3    | ≤0.5%                                | ≤0.1%                                | ≤0.1%                                |
|  <b>Modulus of Rupture</b>            | BS EN ISO 10545-4    | ≥35 N/mm <sup>2</sup>                | ≥40 N/mm <sup>2</sup>                | ≥40 N/mm <sup>2</sup>                |
|  <b>Breaking Strength</b>             | BS EN ISO 10545-4    | ≥1300N                               | ≥1500N                               | ≥1600N                               |
|  <b>Resistance to deep abrasion</b>   | BS EN ISO 10545-6    | ≤175/mm <sup>3</sup>                 | ≤150/mm <sup>3</sup>                 | ≤150/mm <sup>3</sup>                 |
|  <b>Linear Thermal Expansion</b>      | BS EN ISO 10545-8    | ≤9x10 <sup>-6</sup> /°C <sup>1</sup> | ≤7x10 <sup>-6</sup> /°C <sup>1</sup> | ≤7x10 <sup>-6</sup> /°C <sup>1</sup> |
|  <b>Resistance to Thermal Shock</b>   | BS EN ISO 10545-9    | No visible defect                    | No visible defect                    | No visible defect                    |
|  <b>Frost Resistance</b>              | BS EN ISO 10545-12   | No visible damage                    | No visible damage                    | No visible damage                    |
|  <b>Resistance to chemicals</b>       | BS EN ISO 10545-13   | No visible defect                    | No visible defect                    | No visible defect                    |
|  <b>Resistance to stains</b>          | BS EN ISO 10545-14   | Manufacturer to state class          | Stain removed Min. class 2           | Stain removed Min. class 2           |
|  <b>Colour Resistance to UV Light</b> | DIN 51094            | No change in color                   | No change in color                   | No change in color                   |

**Note:** Shade variation across the batches is inherent to the manufacturing process and the pre-laying colour comparison is recommended

## TECHNICAL FEATURES

### GRES WHITE BODY TILES (BIIA) :

Gres white body tiles are created by mixing raw materials including high quality white or red clays, quartz and feldspar in wet grinding ball mills. After grinding, a clay-based suspension of these materials called a slip is fed out of the mill then spray-dried to remove excess moisture. Following the spray drying process, the free flowing powder is pressed using advanced hydraulic presses with a specific pressing power exceeding 300 kg/cm<sup>2</sup> in order to obtain a compact gres body. Once dried, the tiles are coated and decorated with glazes to make them aesthetically pleasing and meet our customers design requirements.

The glazed tile body is then fired in roller kilns where temperatures of approximately 1200 °C are reached. The resulting product is normally a medium-to-low porosity (3% to 5%) tile, in compliance with the International Standard ISO 13006 and European Standard UNI EN 14411 standard and rated as belonging to the BIla GL group with notable technological specifications such as the product flexural strength (average value: 30N/mm<sup>2</sup> according to UNI EN ISO 10545-4).

As for wear resistance, this will depend on the type and colour of glazing and may change according to different products or collections. As a general rule, bright finishes are not recommended for heavy traffic floors or rooms opening onto outdoor areas, where sand or other abrasive materials are more likely to be brought in.

#### ADVICE ON LAYING

Our gres white body tiles can be laid using either traditional cement mortar or modern tile adhesives. When laying large size tiles, it is best to adopt the two-layer spreading system to ensure the adhesive is spread over 90 % of the tile surface.

Quickly dipping each tile in water before installation will remove any dust on the back of the tile for perfect adhesion, however, do not wet the tiles if you are using vinyl, acrylic resin adhesives or two-component organic-solvent based adhesive.

It is advisable to always incorporate suitable shrinkage-flexion joints (movement/expansion joints) which must not be spaced more than 4-5 metres apart from one another. These joints must be inserted not only between the tiles, but also reach the levelling compound below, consisting of either cement mortar or dry compound, depending on whether the tiles are set in the traditional manner or using a modern adhesive. The movement joints must be sealed with appropriate materials such as silicone or polyurethane-based sealants, depending on the anticipated traffic of the application area.

Appropriate tile bedding layers should be used such as underlay, damp course, vapour barrier or any other layer necessary to prevent the tiles from detaching themselves or cracking due to water penetration.

#### TECHNICAL CHARACTERISTICS - GRES WHITE BODY TILES (BIIA)

|  | Test Description                                  | Standard Test Method | International Standard ISO 13006     | RAK Ceramics Specifications   |
|--|---|----------------------|--------------------------------------|-------------------------------|
|  | Length & Width                                    | BS EN ISO 10545-2    | +/- 0.6%                             | +/- 0.5%                      |
|  | Thickness   | BS EN ISO 10545-2    | +/- 5.0%                             | +/- 5.0%                      |
|  | Rectangle Squareness                              | BS EN ISO 10545-2    | +/- 0.5%                             | +/- 0.4%                      |
|  | Straightness of sides                             | BS EN ISO 10545-2    | +/- 0.5%                             | +/- 0.4%                      |
|  | Surface Flatness                                  | BS EN ISO 10545-2    | +/- 0.5%                             | +/- 0.4%                      |
|  | Water Absorption                                  | BS EN ISO 10545-3    | 0.5% < E <= 3.0%                     | 0.5% < E <= 3.0%              |
|  | Modulus of Rupture                                | BS EN ISO 10545-4    | >=30 N/mm <sup>2</sup>               | >=35 N/mm <sup>2</sup>        |
|  | Breaking Strength                                 | BS EN ISO 10545-4    | >=1100 N                             | >=1300 N                      |
|  | Resistance to surface abrasion                    | BS EN ISO 10545-7    | Manufacturer to state Abrasion Class | PEI Class 2                   |
|  | Linear Thermal Expansion                          | BS EN ISO 10545-8    | Test Method available                | <=7x10 <sup>-6</sup> /°C      |
|  | Resistance to Thermal Shock                       | BS EN ISO 10545-9    | No visible defect                    | No visible defect             |
|  | Crazing Resistance                                | BS EN ISO 10545-11   | No crazing                           | No crazing                    |
|  | Frost Resistance                                  | BS EN ISO 10545-12   | No visible damage                    | No visible damage             |
|  | Resistance to chemicals & swimming pool salts     | BS EN ISO 10545-13   | Minimum Class B                      | Class A<br>No visible effect  |
|  | Resistance to low concentrations acid and alkalis | BS EN ISO 10545-13   | Manufacturer to state classification | Class LA<br>No visible effect |
|  | Resistance to stains                              | BS EN ISO 10545-14   | Minimum Class 3                      | Stain removed Min. class 4    |

**Note:** Shade variation across the batches is inherent to the manufacturing process and the pre-laying colour comparison is recommended

## MAINTENANCE AND CLEANING OF TILES

Maintenance of ceramic and porcelain tiles on dry surfaces is relatively easy. RAK Ceramics tiles are highly scratch and stain resistant.

- By regularly sweeping the floor, you can help avoid scratches that small pebbles or sand can create.
- Make it a habit to always wipe the soles of your shoes on a mat before entering the house. Thoroughly wipe up any spills using plain warm water.
- While they are not likely to stain your ceramic tiles, spills may stain the grout between the tiles and if they are left to sit for too long, may also stain the actual tiles.
- Plain water is the ideal cleaner because it leaves no residue if you dry the surface of the tiles thoroughly after cleaning.
- If tiles are left wet after cleaning, there may be some unsightly mineral residue after the water dries, but this can easily be removed by spot cleaning.
- If stains resist cleaning with water alone, you can use a mild acidic solution, such as white vinegar. Use it highly diluted and rinse with plain water then dry.
- As food stains are acidic in nature, try using a mild alkaline solution.
- Use common detergents sparingly, rinse with plain water and dry thoroughly.

## SWIMMING POOL ACCESSORIES

All the swimming pool accessories (page 70 to 87) are provided by our recommended partner atecpool internacional espana and can be purchased at A-TECHNOLOGIES FZCO (UAE), That is responsible for availability, price and delivery terms.



## TILE-LAYING RECOMMENDATIONS

All RAK Ceramics products are subject to size and shade variations. Please check the size, batch number, caliber, tone, choice, color, quality of the pieces before the installation, as no claims will be accepted once the tiles are installed.

Place some tiles on the floor - 2 or 3 sqm - and check the overall technical and aesthetic characteristics with care and check if there is enough product to finish the work.

Manufacturer's responsibility is only limited to replacement of defective material if any, prior to fixing of tiles and we will not entertain claim of any nature after the tiles are installed.

Therefore, if any issue is found on the delivered product, the contractor for installation or the client should not install the tiles. The issue should be communicated to RAK Ceramics for investigation and further action for resolution as required.

The substrate must be a compact cement bed. Levelling system ensures flatness between tiles avoiding movements during the mortar setting. This reduces the time for the ceramic laying obtaining a perfect lippage-free finish. Avoid movements between the tiles due to the mortar setting.

The width of grout joints must be established by the installation supervisor, unless grout widths are regulated by national laying standards. The grout colour should be selected according to the colour of the tile. We recommend to select a matching colour. Before using fine-grain coloured grout on lapped, polished or brushed products, always test it. If the pigment is very adhesive, it may be very difficult to remove.

We recommend to lay the tiles by using suitable adhesives for each kind of product and surface. As general rule, tiles must be installed in the same position. The minimum joint is 2 mm for rectified tiles, although we suggest a higher joint for big size products. After grouting, remove any excess product as quickly as possible by repeatedly washing the area with a sponge and water.

Steps to follow 1. First, set the tool to the scale according to the ceramic thickness. 2. Introduce the crossheads and continue laying the adjacent tiles. 3. Put the wedges in the crosshead manually. 4. Tighten the wedges with the pliers to level the pieces. 5. Allow for setting for the time recommended by the manufacturer of the adhesive cement. 6. Remove the crossheads. Hit the crosshead with a rubber mallet or with your foot in the direction of the joint. Do not hit the wedges.

The company will not accept any claim if this is due to the problems caused by not following these suggestions and instructions.

# Product Guide

## ICONS

### COLOUR VARIATIONS



V1 EVEN

The least amount of shade variation attainable.



V2 LIGHT

Light to moderate shade variation within each carton.



V3 MEDIUM

Medium to high shade variation within each carton.

### INDICATIONS FOR USE



WALL TILES



FLOOR TILES

### SUGGESTED APPLICATIONS



DOMESTIC PURPOSE

Residential areas, hotel rooms, bathrooms



LIGHT COMMERCIAL TRAFFIC AREA

Indoor public areas subject to medium pedestrian traffic such as restaurants, bars, offices, shops, hotel public areas, convention rooms.



HEAVY COMMERCIAL TRAFFIC AREA

Industrial floors such as warehouses, deposits, factories.



OUTDOOR

Outdoor public environments subject to medium pedestrian traffic such as outdoor terraces, stairs, corridors, raised paving, private garden, swimming pool and wellness areas. Always check the slipperiness characteristics according to the intended environment, in conformity with applicable regulations or laws.

### R RATING



indicates a normal grip with an inclination plane from 3° to 10°



indicates a medium grip with an inclination plane from 10° to 19°



indicates a high grip with an inclination plane from 19° to 27°

| CLASSIFICATION | TYPICAL APPLICATIONS  | MEAN CRITICAL ANGLE VALUE |
|----------------|---|---------------------------|
| Class A        | Barefoot, but mainly dry aisles and walkways, dry changing areas.   | ≥ 12°                     |
| Class B        | Showroom, pool surrounds, wet changing areas (plus all areas covered by Class A).   | ≥ 18°                     |
| Class C        | Areas constantly under water, e.g. steps into pools, foot baths, inclined pool surrounds, Jacuzzis (plus all areas covered by Class A and B). | ≥ 24°                     |



In printing, colour of the products may differ slightly from actual, pictures are only for reference.

## PACKAGING

| Sizes (cm)       | Thickness (mm) | Pieces X | M² X | Kg X  | X  Sq. Pallet | M² X  Sq. Pallet | kg X  Sq. Pallet | X  Eu. Pallet | M² X  Eu. Pallet | kg X  Eu. Pallet |
|------------------|----------------|----------|------|-------|---------------|------------------|------------------|---------------|------------------|------------------|
| 60x120           | 20             | 1        | 0.72 | 32.40 | -             | -                | -                | 38            | 27.36            | 1247.00          |
| 60x120           | 9              | 2        | 1.44 | 30.00 | -             | -                | -                | 30            | 43.20            | 921.00           |
| 60x60            | 9              | 4        | 1.44 | 30.00 | -             | -                | -                | 30            | 43.20            | 921.00           |
| 60x60            | 20             | 2        | 0.72 | 32.00 | -             | -                | -                | 30            | 21.60            | 1000.00          |
| 30x60            | 9              | 6        | 1.08 | 23.00 | -             | -                | -                | 30            | 43.20            | 921.00           |
| 11.7X24.5        |                | 28       | 0.8  | 13.50 | 112           | 89.60            | 1512.00          | 96            | 76.80            | 1296.00          |
| Mosaic 30x30     | 9              | 10       | -    | 14.00 | -             | -                | -                | 48            | -                | 672.00           |
| Mosaic 28.8x28.8 | 9              | 6        | -    | 12.00 | -             | -                | -                | 48            | -                | 576.00           |
| Mosaic 25.5x29.5 | 9              | 10       | -    | 17.50 | 54            | -                | 980.00           | -             | -                | -                |
| Mosaic 30x40     | 9              | 8        | -    | 13.00 | -             | -                | -                | 48            | -                | 624.00           |
| Mosaic 30x45     | 9              | 6        | -    | 15.00 | -             | -                | -                | 30            | -                | 450.00           |
| Mosaic 30x60     | 9              | 6        | -    | 17.00 | -             | -                | -                | 30            | -                | 510.00           |
| Steps 30x120     | 9              | 2        | 0.72 | 20.00 | -             | -                | -                | -             | -                | -                |
| Steps 29.8x60    | 9              | 6        | 1.05 | 24.00 | 48            | 50.40            | 1162.00          | 48            | 50.40            | 1162.00          |
| Skirting 60x8    | 9              | 18       | -    | 19.00 | 80            | -                | 1520.00          | -             | -                | -                |



## R RATING TABLE

| Collections         | Typology                  | Colours     | R  | R  (20mm thickness) |
|---------------------|---------------------------|-------------|--|--|
| Breccia Adige Stone | Porcelain Tiles           | Beige       | R11 / A+B  | -  |
|                     |                           | Brown       | R11 / A+B  | -  |
|                     |                           | Taupe       | R11 / A+B  | -  |
|                     |                           | White       | R11 / A+B  | -  |
| Bryce               | Porcelain Tiles           | Anthracite  | -  | R11 / A+B  |
|                     |                           | White       | -  | R11 / A+B  |
|                     |                           | Gold        | -  | R11 / A+B  |
| Burano              | Porcelain Tiles           | White       | R11 / A+B  |  |
|                     |                           | Grey        | R11 / A+B  |  |
|                     |                           | Dark Grey   | R11 / A+B  |  |
| Carmo Stone         | Porcelain Tiles           | Anthracite  | -  | R11 / A+B  |
|                     |                           | Black       | -  | R11 / A+B  |
|                     |                           | Grey        | -  | R11 / A+B  |
|                     |                           | Ivory       | -  | R11 / A+B  |
| Coral Stone         | Porcelain Tiles           | light Grey  | -  | R11 / A+B  |
|                     |                           | Grey        | -  | R11 / A+B  |
|                     |                           | ivory       | -  | R11 / A+B  |
|                     |                           | Beige       | -  | R11 / A+B  |
| Core Stone          | Porcelain Tiles           | Grey        | -  | R11 / A+B  |
|                     |                           | Anthracite  | -  | R11 / A+B  |
|                     |                           | Beige       | -  | R11 / A+B  |
|                     |                           | Brown       | -  | R11 / A+B  |
| Creative Concrete   | Porcelain Tiles           | Grey        | -  | R11 / A+B  |
|                     |                           | Dark Grey   | -  | R11 / A+B  |
|                     |                           | White       | -  | R11 / A+B  |
| Curton              | Full Body Porcelain Tiles | white decor | R11 / A+B  | -  |
|                     |                           | grey decor  | R11 / A+B  | -  |
|                     |                           | beige decor | R11 / A+B  | -  |
| Design Concrete     | Porcelain Tiles           | Light Grey  | -  | R11 / A+B  |
|                     |                           | Dark Grey   | -  | R11 / A+B  |
|                     |                           | Ivory       | -  | R11 / A+B  |
|                     |                           | Nut         | -  | R11 / A+B  |
| French vanilla      | Porcelain Tiles           | Anthracite  | -  | R11 / A+B  |
|                     |                           | Beige       | -  | R11 / A+B  |
|                     |                           | Grey        | -  | R11 / A+B  |
| Fashion Stone       | Porcelain Tiles           | Light Grey  | R11 / A+B  | R11 / A+B  |
|                     |                           | Grey        | R11 / A+B  | R11 / A+B  |
|                     |                           | Black       | R11 / A+B  | R11 / A+B  |
|                     |                           | Ivory       | R11 / A+B  | R11 / A+B  |
|                     |                           | Beige       | R11 / A+B  | R11 / A+B  |
| Clay                | R11 / A+B                 | R11 / A+B   |  |  |

| Collections     | Typology                  | Colours       | R  | R  (20mm thickness) |
|-----------------|---------------------------|---------------|---|--|
| Lapideus        | Full Body Porcelain Tiles | White         | R10 / A+B+C   | -  |
|                 |                           | slate grey    | R10 / A+B+C   | -  |
|                 |                           | beige         | R10 / A+B+C   | -  |
|                 |                           | original      | R10 / A+B+C   | -  |
| Lava Concrete   | Full Body Porcelain Tiles | White         | R10 / A+B+C   | -  |
|                 |                           | Light Grey    | R10 / A+B+C   | -  |
|                 |                           | Beige         | R10 / A+B+C   | -  |
| Revive Concrete | Porcelain Tiles           | active white  | -   | R11 / A+B  |
|                 |                           | concrete grey | -   | R11 / A+B  |
|                 |                           | graphite grey | -   | R11 / A+B  |
|                 |                           | pitch black   | -   | R11 / A+B  |
|                 |                           | cloud grey    | -   | R11 / A+B  |
|                 |                           | blade beige   | -   | R11 / A+B  |
| Shine Stone     | Porcelain Tiles           | white         | R11 / A+B   | -  |
|                 |                           | grey          | R11 / A+B   | -  |
|                 |                           | dark grey     | R11 / A+B   | -  |
|                 |                           | black         | R11 / A+B   | -  |
|                 |                           | ivory         | R11 / A+B   | -  |
|                 |                           | beige         | R11 / A+B   | -  |
|                 |                           | dark beige    | R11 / A+B   | -  |
| brown           | R11 / A+B                 | -             |   |  |
| Surface 2.0     | Porcelain Tiles           | Cool Grey     | -   | R11 / A+B  |
|                 |                           | mid grey      | -   | R11 / A+B  |
|                 |                           | ash           | -   | R11 / A+B  |
|                 |                           | night         | -   | R11 / A+B  |
|                 |                           | Sand          | -   | R11 / A+B  |
| copper          | -                         | R11 / A+B     |   |  |

RAK CERAMICS  
P.O. Box 4714, Ras Al Khaimah,  
United Arab Emirates (U.A.E.)  
Tel.: +971 7 2467000  
Fax: +971 7 2445270  
Email : info@rakceramics.com

---

**RAKCERAMICS.COM**

---

Note: In printing, colour of the products may differ slightly from actual, pictures are only for reference.

**RAK**  
CERAMICS